



CDTech(H.K.)Electronics Limited

Product Specification

Model Name	S035CHV54NS
Description	TFT LCD Module 3.5" HVGA 320(RGB)x480 Dots
Date	2019/5/15
Version	1.0

Approved by/Date	Check by/Date	Prepared by/Date
ZHP 2019/9/04	HZX 2019/9/04	Yigui.Han 2019/9/04

Customer Approval	
Date	



CDTech(H.K.)Electronics Limited

Table of Contents

1.Record of Revision	3
2.General Specifications	4
3.Input/Output Terminals	5
4.Absolute Maximum Rating	5
5.Timing characteristics	6
6.Interface Timing	7
7.Optical Characteristics	13
8.Environmental / Reliability Tests	17
9.Mechanical Drawing	18
10.Packing	19
11.Precautions for Use of LCD modules	20

2. General Specifications

Feature		Spec
Characteristics	Size	3.5 inch
	Resolution	320(horizontal)*480(Vertical)
	Interface	RGB 24 bit
	Connect type	Connector
	Technology type	a-Si
	Pixel pitch (mm)	0.153*0.153
	Pixel Configuration	R.G.B.-Stripe
	Display Mode	Normally Black
	Driver IC	ILI9488
	Viewing Direction	ALL
Mechanical	LCM (W x H x D) (mm)	54.76*83.58*2.5
	Active Area(mm)	48.96*73.44
	With /Without TSP	Without TSP
	Weight (g)	TBD
	LED Numbers	6 LEDS

Note 1: Requirements on Environmental Protection: RoHs

Note 2: LCM weight tolerance: +/- 5%

3. Input/Output Terminals

No.	Symbol	Description
1	GND	System Ground
2	LEDA	Backlight LED Anode.
3	LEDK	Backlight LED Cathode.
4	VCC	A supply voltage to the analog circuit.
5	IOVCC	A supply voltage to the digital circuit.
6	SDO	Serial data output.
7	SDI	Serial data input/output..
8	GND	System Ground
9	SCL_WR	SCL pin as Serial Clock.
10	CS	Chip select input signal.
11	NC	-
12	RESET	Reset signal.
13-20	R0-R7	Data bus.
21-28	G0-G7	Data bus.
29-36	B0-B7	Data bus
37	DE	Data enable input.
38	GND	System Ground
39	PCLK	Dot clock signal input.
40	GND	System Ground
41	HS	Horizontal sync input. Negative polarity.
42	VS	Vertical sync input. Negative polarity.
43	IC_ID	-
44	LED_PWM	The PWM frequency output for LED driver control.
45	GND	System Ground

4. Absolute Maximum Rating

Item	Symbol	MIN	Typ	MAX	Unit	Remark
Supply Voltage	V _{DD}	-0.3	-	5.0	V	-
Operating Temperature	T _{OPR}	-20	-	70	°C	-
Storage Temperature	T _{STG}	-30	-	80	°C	-

5. Electrical characteristics

5.1 Driving TFT LCD Panel

Item		Symbol	MIN	TYP	MAX	Unit	Remark
Supply Voltage		V _{cc}	2.5	2.8	3.3	V	
		IOVCC	1.65	1.8	3.3		
Input Signal Voltage	Low Level	V _{IL}	-0.3	-	0.3x IOVCC	V	
	High Level	V _{IH}	0.7x IOVCC	-	IOVCC	V	
Output Signal Voltage	Low Level	V _{OL}	0	-	0.2*IOVCC	V	
	High Level	V _{OH}	0.8*IOVCC	-	IOVCC	V	

5.2 Current voltage power consumption

Parameter	Symbol	Condition	MIN	TYP	MAX	Unit	Remark
Supply Current	V _{cc}	VCC=2.8V	-	8	12	mA	
	IOVCC	IOVCC=1.8V	-	4	6	mA	
Total Power Consumption	PC V _{cc}	VCC=2.8V	-	0.0224	0.0336	mW	
	PC IO _{vcc}	IOVCC=1.8V	-	0.0072	0.0108	mW	

5.3 LED Driving Conditions

Item	Symbol	MIN	TYP	MAX	Unit	Remark
Forward Current	I _F	-	20	-	mA	
Forward Voltage	V _F	8	19.2	20.4	V	
Backlight Power consumption	W _{BL}	-	0.384	-	W	
LED Lifetime		-	30000	-	Hrs	

Note 1: Each LED: I_F =20 mA, V_F =3.2+/-0.2V.

Note 2: Optical performance should be evaluated at Ta=25°C only.

Note 3: If LED is driven by high current, high ambient temperature & humidity condition. The life Time of LED will be reduced. Operating life means brightness goes down to 50% initial brightness. Typical operating life time is estimated data.

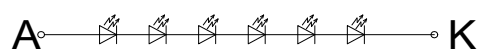

LED CIRCUIT DIAGRAM

Figure: LED connection of backlight(Constant Current)

6 Interface Timing

6.1 DC Characteristics for Panel Driving

Item	Symbol	Condition	Min.	Typ.	Max.	Unit	Note
Power & Operation Voltage							
Analog operating voltage	VCI	-	2.5	2.8	3.3	V	
Logic operating voltage	IOVCC	-	1.65	1.8	3.3	V	Note 1, 2
OTP Supply voltage	DDVDH	-	-	7	-	V	Note 1
Logic High level input voltage	VIH	-	0.7*IOVCC		IOVCC	V	Note 1
Logic Low level input voltage	VIL	-	-0.3		0.3*IOVCC	V	Note 1
Logic High level output voltage TE, SDO (SDA), CABC_PWM_OUT	VOH	IOH = -1.0mA	0.8*IOVCC		IOVCC	V	Note 1
Logic Low level output voltage TE, SDO (SDA), CABC_PWM_OUT	VOL	IOL = +1.0mA	0		0.2*IOVCC	V	Note 1
Gate Driver High Voltage	VGH	-	10.0	-	20	V	
Gate Driver Low Voltage	VGL	-	-15.0	-	-6.0	V	
Driver Supply Voltage	-	VGH-VGL	16	-	32	V	
Input and Output							
Logic High Level Input Voltage	VIH	-	0.7*IOVCC	-	IOVCC	V	
Logic Low Level Input Voltage	VIL	-	DGND	-	0.3*IOVCC	V	
VCOM Operation							
DC VCOM Amplitude Voltage	VCOM	-	-2.0	-	-0.06	V	Note 3
Source Driver							
Source Output Range	VSOUT	-	0.1	-	VREG1OUT-0.1	V	Note 4
Positive Gamma Reference Voltage	VREG1OUT	-	3.625	-	5.5	V	
Negative Gamma Reference Voltage	VREG2OUT	-	-5.5	-	-3.625	V	
Source Output Setting Time	Tr	Below with 99% precision	-	10	-	uS	Note 3, 4
Output Deviation Voltage (Source Output channel)	Vdev	Sout>=4.2V	-	-	20	mV	Note 3
		Sout<=0.8V	-	-	15	mV	-
Output Offset Voltage	VOFFSET	-	-	-	35	mV	Note 3
Booster Operation							
Booster (VCIx2) Voltage	DDVDH	-			6	V	
Booster (VCIx2) Voltage	DDVDL	-	-6			V	
Booster (VCIx2 Drop Voltage)	VCI1x2 drop	loading=1mA	-	-	5	%	
Gate Driver High Voltage	VGH	-	10.0	-	20	V	
Gate Driver Low Voltage	VGL	-	-15.0	-	-6.0	V	
Standby mode current consumption (Ta = 25 °C, Interface: DBI and DPI)							
Sleep in mode	VCI	VCI=2.8V	-	100	-	uA	
Deep Standby mode	VCI	IOVCC=1.8V	-	1	-	uA	

Notes:

1. Ta = -30 to 70 °C (no damage up to 85°C (at maximum)), IOVCC=1.65V to 3.3V, VCI=2.5V to 3.3V, DGND=0V.
2. Supply the digital IOVCC voltage equal to or less than the analog VCI voltage.
3. Source channel loading = 10KΩ,30pF/channel
4. The maximum value is between 10KΩ,30pF/channel and Gamma setting value.

6.2 DPI Parallel Interface (RGB Interface) Characteristics

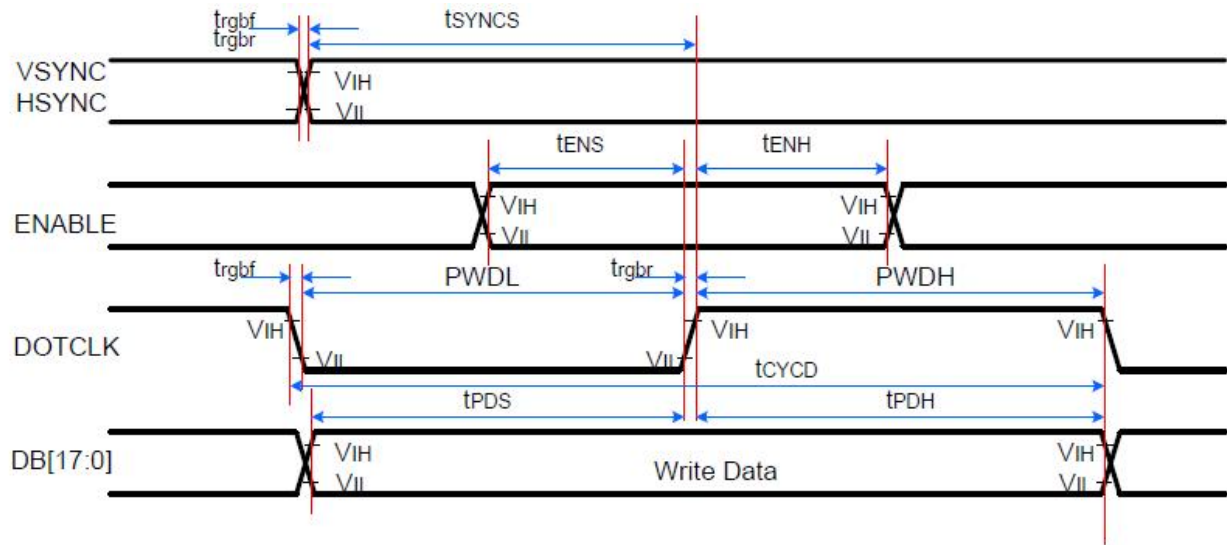

Signal	Symbol	Parameter	min	max	Unit	Description
VSYNC/ HSYNC	t_{SYNCS}	VSYNC/HSYNC setup time	15	-	ns	16-/18-/24-bit bus RGB interface mode
	t_{SYNCH}	VSYNC/HSYNC hold time	15	-	ns	
ENABLE	t_{ENS}	ENABLE setup time	15	-	ns	
	t_{ENH}	ENABLE hold time	15	-	ns	
DB [23:0]	t_{POS}	Data setup time	15	-	ns	
	t_{PDH}	Data hold time	15	-	ns	
DOTCLK	$PWDH$	DOTCLK high-level period	20	-	ns	
	$PWDL$	DOTCLK low-level period	20	-	ns	
	t_{CYCD}	DOTCLK cycle time	50	-	ns	
	t_{rgb}, t_{rgb}	DOTCLK,HSYNC,VSYNC rise/fall time	-	15	ns	

Note: $T_a = -30$ to 70 °C, $IOVCC = 1.65V$ to $3.3V$, $VCI = 2.5V$ to $3.3V$, $AGND = DGND = 0V$

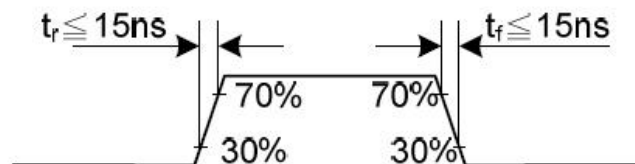

6.3 DPI Parallel Interface (RGB Interface) Timing

The DPI can display moving pictures by two ways: rewrite into the GRAM and transmit directly to the shift register. The selection is set by the register BPGRAM (bypass GRAM) and RM bit. The RM bit selects an interface for the access operation of the Frame Memory. For the DPI, RM should be set as 1.

BPGRAM	Display Data Path
1	Direct to shift register
0	Write into Memory
RM	Interface for RAM access
0	System interface
1	RGB interface

The DM bit selects the clock operation mode. It allows switching between display operations in synchronization with the internal oscillation clock. If DM = 1, the external DOTCLK cannot be stopped unless it enters the Sleep-In mode.

DM	RGB Interface Operating Clock Selection
0	Internal system clock
1	RGB interface (DOTCLK)

4.5.1. RGB Interface Selection

The DPI can be selected by the RCM bit. When the RCM is set to 0, the DE mode is selected by VSYNC, HSYNC, DOTCLK, ENABLE, and DB [23:0] pins. When RCM is set to 1, the SYNC mode is selected by VSYNC, HSYNC, DOTCLK, and DB [23:0] pins. It supports several pixel formats that can be selected by DPI [2:0] bits in Pixel Format Set (R3Ah) command. The selection of a given interface is done by DPI [2:0], as shown in Table 6 and Figure 17.

Table 6: DPI Interface Selection

RCM	DPI [2:0]			RGB Interface Mode	RGB Mode	Used Pins
0	1	1	1	24-bit RGB interface (16.7M colors)	DE Mode Valid data is determined by the ENABLE signal.	VSYNC, HSYNC, ENABLE, DOTCLK, DB [23:0]
0	1	1	0	18-bit RGB interface (262K colors)		VSYNC, HSYNC, ENABLE, DOTCLK, DB [17:0]
0	1	0	1	16-bit RGB interface (65K colors)		VSYNC, HSYNC, ENABLE, DOTCLK, DB [15:0]
1	1	1	1	24-bit RGB interface (16.7M colors)	SYNC Mode In the SYNC mode, ENABLE signal is ignored; blanking porch is determined by B5h command.	VSYNC, HSYNC, DOTCLK, DB [23:0]
1	1	1	0	18-bit RGB interface (262K colors)		VSYNC, HSYNC, DOTCLK, DB [17:0]
1	1	0	1	16-bit RGB interface (65K colors)		VSYNC, HSYNC, DOTCLK, DB [15:0]

24-bit DPI interface connection (DB [23:0] is used): set pixel format DPI [2:0] = 3'h7

DB23	DB22	DB21	DB20	DB19	DB18	DB17	DB16	DB15	DB14	DB13	DB12	DB11	DB10	DB9	DB8	DB7	DB6	DB5	DB4	DB3	DB2	DB1	DB0
R[7]	R[6]	R[5]	R[4]	R[3]	R[2]	R[1]	R[0]	G[7]	G[6]	G[5]	G[4]	G[3]	G[2]	G[1]	G[0]	B[7]	B[6]	B[5]	B[4]	B[3]	B[2]	B[1]	B[0]

18-bit DPI interface connection (DB [17:0] is used): set pixel format DPI [2:0] = 3'h6

DB23	DB22	DB21	DB20	DB19	DB18	DB17	DB16	DB15	DB14	DB13	DB12	DB11	DB10	DB9	DB8	DB7	DB6	DB5	DB4	DB3	DB2	DB1	DB0		
								R[5]	R[4]	R[3]	R[2]	R[1]	R[0]	G[5]	G[4]	G[3]	G[2]	G[1]	G[0]	B[5]	B[4]	B[3]	B[2]	B[1]	B[0]

16-bit DPI interface connection (DB [15:0] is used): set pixel format DPI [2:0] = 3'h5

DB23	DB22	DB21	DB20	DB19	DB18	DB17	DB16	DB15	DB14	DB13	DB12	DB11	DB10	DB9	DB8	DB7	DB6	DB5	DB4	DB3	DB2	DB1	DB0	
								R[4]	R[3]	R[2]	R[1]	R[0]	G[5]	G[4]	G[3]	G[2]	G[1]	G[0]	B[4]	B[3]	B[2]	B[1]	B[0]	

Figure 17: DPI Interface 24/18/16 Pixel Format Selection

The Pixel clock (DOTCLK) runs all the time without stop. It is used to enter VSYNC, HSYNC, ENABLE and DB [23:0] states when there is a rising edge of the DOTCLK. The DOTCLK cannot be used as the internal clock for other functions of the display module.

Vertical synchronization (VSYNC) is used to indicate when a new frame of the display is received. This is low enable and its state is read to the display module by a rising edge of the DOTCLK signal.

Horizontal synchronization (HSYNC) is used to indicate when a new line of the frame is received. This is low enable and its state is read to the display module by a rising edge of the DOTCLK signal.

Data Enable (ENABLE) is used to indicate when the RGB information that should be transferred in the display is received. This is a high enable, and its state is read to the display module by a rising edge of the DOTCLK signal.

DB [23:0] is used to indicate what is the information of the image that is transferred on the display (when ENABLE = 0 (low) and there is a rising edge of DOTCLK). DB [23:0] can be 0 (low) or 1 (high). These lines are read by a rising edge of the DOTCLK signal. In RGB interface modes, the input display data is written to GRAM first then outputs the corresponding source voltage according to the gray data from GRAM.

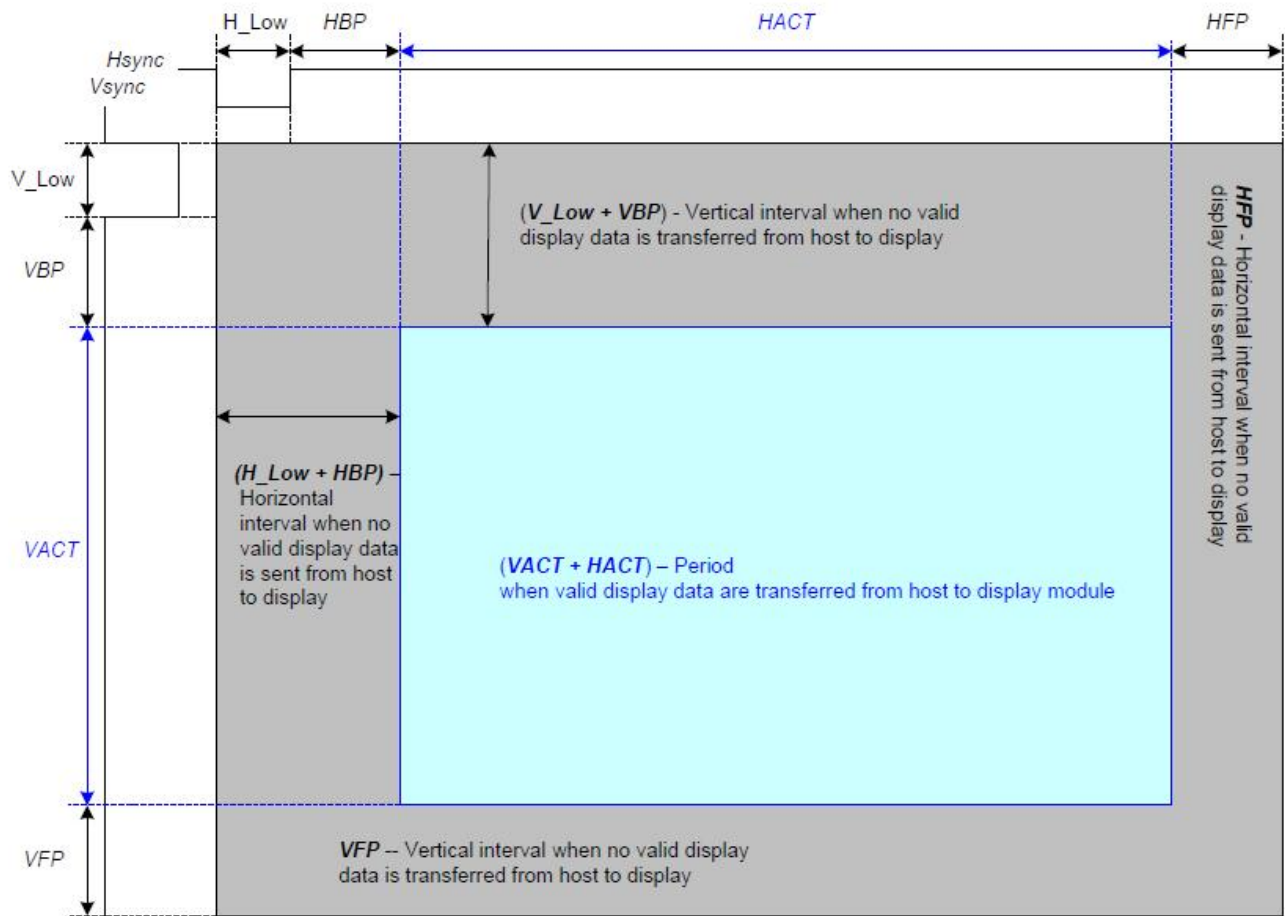

Figure 18: General DPI Timing Diagram

Parameters	Symbols	Min.	Typ.	Max.	Units
Horizontal Synchronization	H_Low	3	-	-	DOTCLK
Horizontal Back Porch	HBP	3	-	-	DOTCLK
Horizontal Address	HACT	-	320	-	DOTCLK
Horizontal Front Porch	HFP	3	-	-	DOTCLK
Horizontal Frequency		-	-	33	KHz
Vertical Synchronization	V_Low	1	-	-	Line
Vertical Back Porch	VBP	2	-	-	Line
Vertical Address	VACT	-	480	-	Line
Vertical Front Porch	VFP	2	-	-	Line
Vertical Frequency		60	-	70	Hz
DOTCLK cycle		100	-	50	ns
DOTCLK Frequency		10	-	20	MHz

Example : DOTCLK = 20Mhz, TE=70Hz, V_Low+VBP=2, VFP=2, H_Low+HBP=100, HFP=170.

The timing chart of 16-/18-/24-bit DPI interface mode is illustrated in Figure 19.

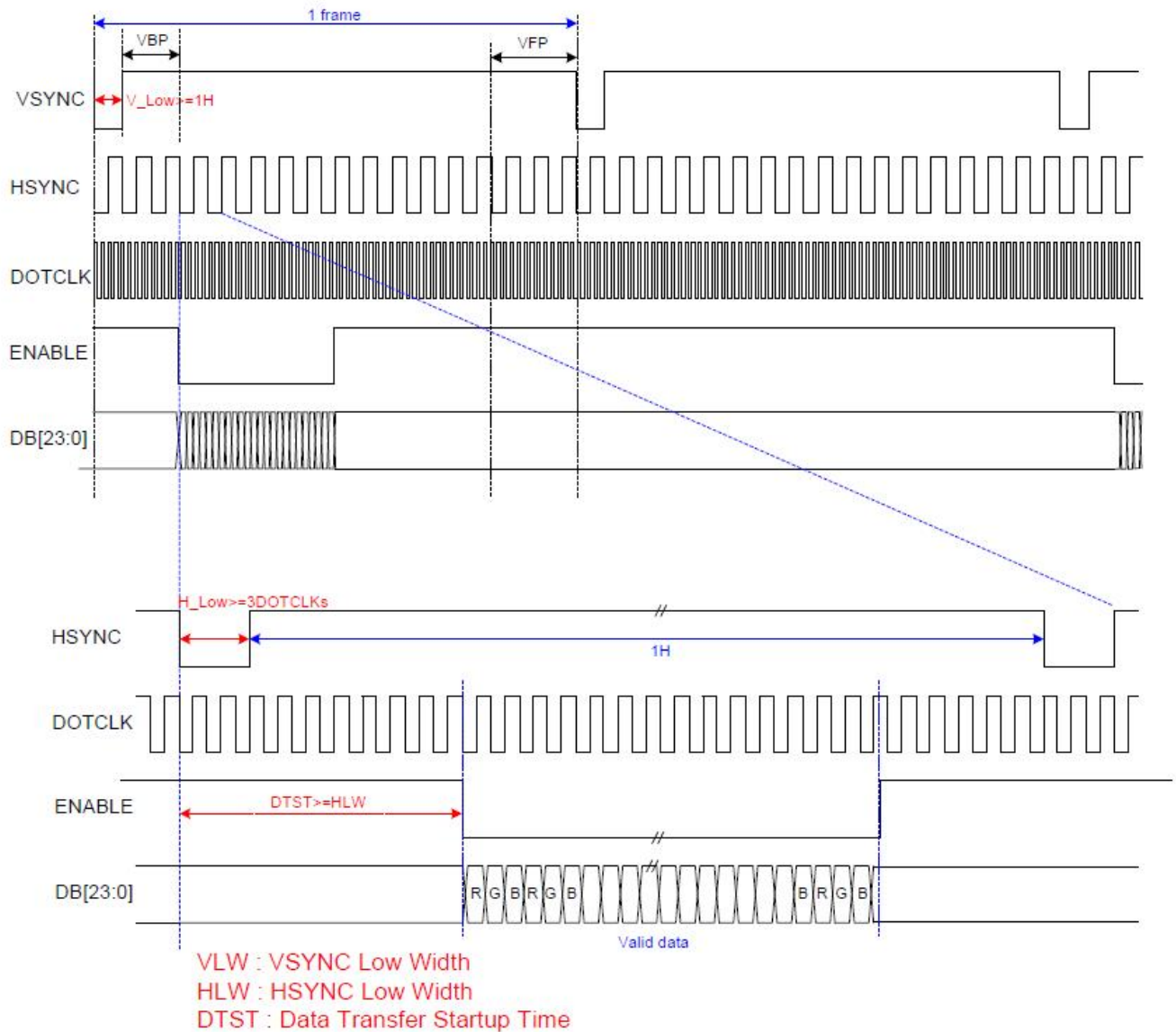

Figure 19: DPI Interface Timing Diagram

Note: VSPL = 0, HSPL = 0, DPL = 0 and EPL = 0 of Interface Mode Control B0h command.

7 Optical Characteristics

Items		Symbol	Condi on	Min.	Typ.	Max.	Unit	Remark	Note
Response time		Tr+Tf	-	-	30	-	ms	FIG.1	Note4
Contrast Ratio		CR		550	700	-	-	FIG.2	Note1
Surface luminance		LV	$\theta = 0^\circ$	350	400	-	cd/m ²	FIG.2	Note2
Luminance uniformity		Yu	$\theta = 0^\circ$	70	80	-	%	FIG.2	Note3
NTSC		-	$\theta = 0^\circ$	-	50	-	%	FIG.2	Note5
Viewing angle		θ Cr>10	$\varnothing = 90^\circ$	70	80	-	deg	FIG.3	Note6
			$\varnothing = 270^\circ$	70	80	-	deg	FIG.3	
			$\varnothing = 0^\circ$	70	80	-	deg	FIG.3	
			$\varnothing = 180^\circ$	70	80	-	deg	FIG.3	
Chromaticity	Red	R _X	$\theta = 0^\circ$	0.5929	0.6429	0.6929	-	FIG.2 CIE1931	Note5
		R _Y		0.2926	0.3426	0.3926	-		
	Green	G _X	$\varnothing = 0^\circ$	0.3063	0.3563	0.4063	-		
		G _Y		0.5569	0.6069	0.6569	-		
	Blue	B _X	Ta=25°	0.0995	0.1495	0.1995	-		
		B _Y		0.0074	0.0426	0.0926	-		
	White	W _X	0.2746	0.3246	0.3746	-			
		W _Y	0.2984	0.3484	0.3984	-			

Note1. Definition of contrast ratio

Contrast ratio(Cr) is defined mathematically by the following formula. For more information see FIG.2.

$$\text{Contrast ratio} = \frac{\text{Luminance measured when LCD on the "White" state}}{\text{Luminance measured when LCD on the "Black" state}}$$

For contrast ratio, Surface Luminance, Luminance uniformity and CIE, the testing data is based on TOPCON's BM-5 or BM-7 photo detector or compatible.

Note2. Definition of surface luminance.

Surface luminance is the luminance with all pixels displaying white. For more information see FIG.2.

L_v = Average Surface Luminance with all white pixels ($P_1, P_2, P_3, \dots, P_n$)

Note3. Definition of luminance uniformity

The luminance uniformity in surface luminance is determined by measuring luminance at each test position 1 through n, and then dividing the maximum luminance of n points luminance by minimum luminance of n points luminance. For more information see FIG.2.

$$YU = \frac{\text{Minimum surface luminance with all white pixels } (P_1, P_2, P_3, \dots, P_n)}{\text{Maximum surface luminance with all white pixels } (P_1, P_2, P_3, \dots, P_n)}$$

Note4. Definition of response time

The response time is defined as the LCD optical switching time interval between "White" state and "Black" state. Rise time (T_r) is the time between photo detector output intensity changed from 90% to 10%. And fall time (T_f) is the time between photo detector output intensity changed from 10% to 90%.

For additional information see FIG1.

Note5. Definition of color chromaticity (CIE1931)

CIE (x,y) chromaticity, The x,y value is determined by screen active area center position P5. For more information see FIG.2.

Note6. Definition of viewing angle

Viewing angle is the angle at which the contrast ratio is greater than 10. Angles are determined for the horizontal or x axis and the vertical or y axis with respect to the z axis which is normal to the LCD surface. For more information see FIG.3.

For viewing angle and response time testing, the testing data is based on Autronic-Melchers' s ConoScope or DMS series Instruments or compatible.

FIG.1. The definition of response Time

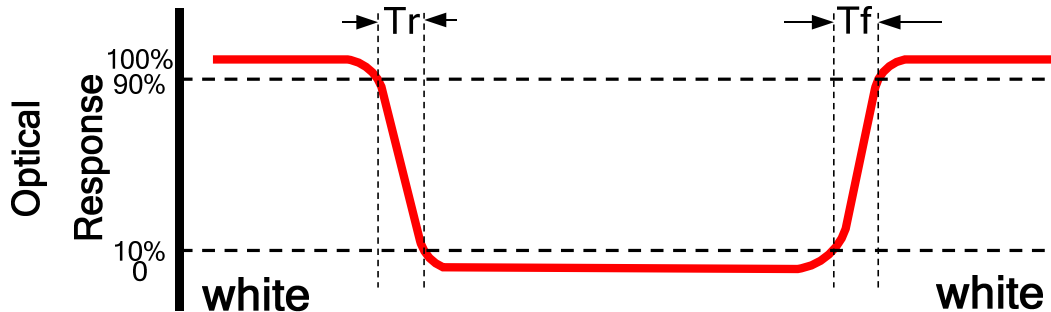

FIG.2. Measuring method for contrast ratio, surface luminance,

luminance uniformity, CIE (x,y) chromaticity

Size : $S \leq 5''$ (see Figure a) A : 5 mm B : 5 mm

H, V : Active area

Light spot size $\varnothing = 5\text{mm}$ (BM-5) or $\varnothing = 7.7\text{mm}$ (BM-7) 50cm distance or compatible distance from the LCD surface to detector lens.

test spot position : see Figure a.

measurement instrument : TOPCON's luminance meter BM-5 or BM-7 or compatible (see Figure c).

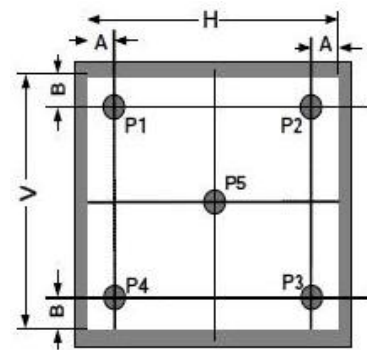

Figure a

Size : $5'' < S \leq 12.3''$ (see Figure b) H, V : Active area

Light spot size $\varnothing = 5\text{mm}$ (BM-5) or $\varnothing = 7.7\text{mm}$ (BM-7) 50cm distance or compatible distance from the LCD surface to detector lens.

test spot position : see Figure b.

measurement instrument : TOPCON's luminance meter BM-5 or BM-7 or compatible (see Figure c).

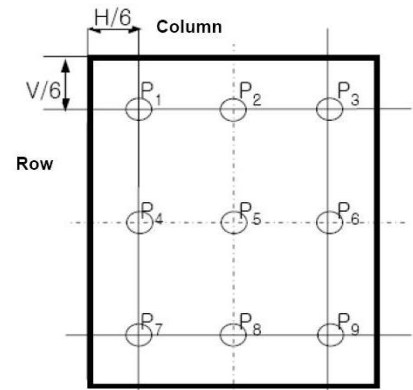

Figure b

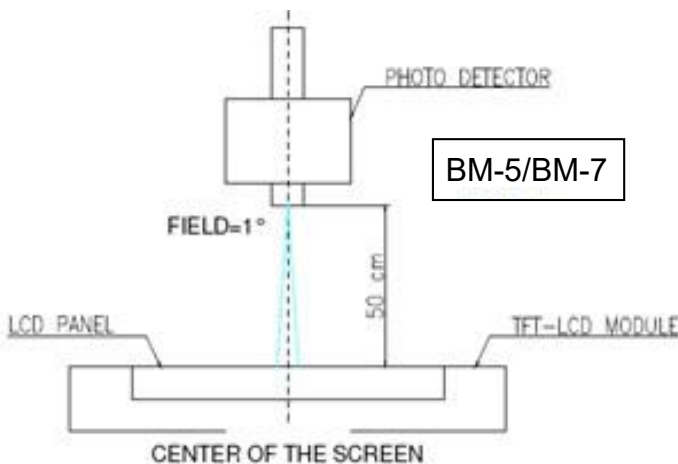
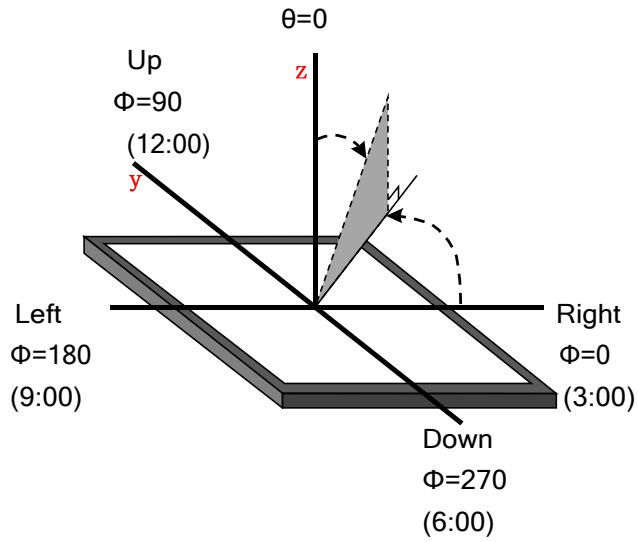

Figure c

FIG.3.The definition of viewing angle



8 Environmental / Reliability Tests

No	Test Item	Condition	Remarks
1	High Temperature Operation	Ts= +70°C, 96hrs	Note 1 IEC60068-2-2, GB2423. 2-89
2	Low Temperature Operation	Ta= -20°C, 96hrs	Note 2 IEC60068-2-1 GB2423.1-89
3	High Temperature Storage	Ta= +80°C, 120hrs	IEC60068-2-2 GB2423. 2-89
4	Low Temperature Storage	Ta= -30°C, 120hrs	IEC60068-2-1 GB/T2423.1-89
5	High Temperature & Humidity Storage	Ta= +60°C, 90% RH max,120 hours	IEC60068-2-3 GB/T2423.3-2006
6	Thermal Shock (Non-operation)	-20°C 30 min ~ +60°C 30 min Change time: 5min, 30 Cycle	Start with cold temperature, end with high temperature IEC60068-2-14, GB2423.22-87
7	Electro Discharge (Operation) Static	C=150pF, R=330 Ω, 5 points/panel Air:±8KV, 5 times; Contact: ±4KV, 5 times; (Environment: 15°C ~ 35°C, 30% ~ 60%, 86Kpa ~ 106Kpa)	IEC61000-4-2 GB/T17626.2-1998
8	Vibration (Non-operation)	Frequency range: 10~55Hz, Stroke: 1.mm Sweep: 10Hz~55Hz~10Hz 2 hours for each direction of X .Y. Z. (package condition)	IEC60068-2-6 GB/T2423.5-1995
9	Shock (Non-operation)	60G 6ms, ± X, ±Y , ± Z 3 times for each direction	IEC60068-2-27 GB/T2423.5-1995
10	Package Drop Test	Height: 80 cm, 1 corner, 3 edges, 6 surfaces	IEC60068-2-32 GB/T2423.8-1995

- Note:1. Ts is the temperature of panel's surface.
2. Ta is the ambient temperature of sample.
3. The size of sample is 5pcs.

9 Mechanical Drawing

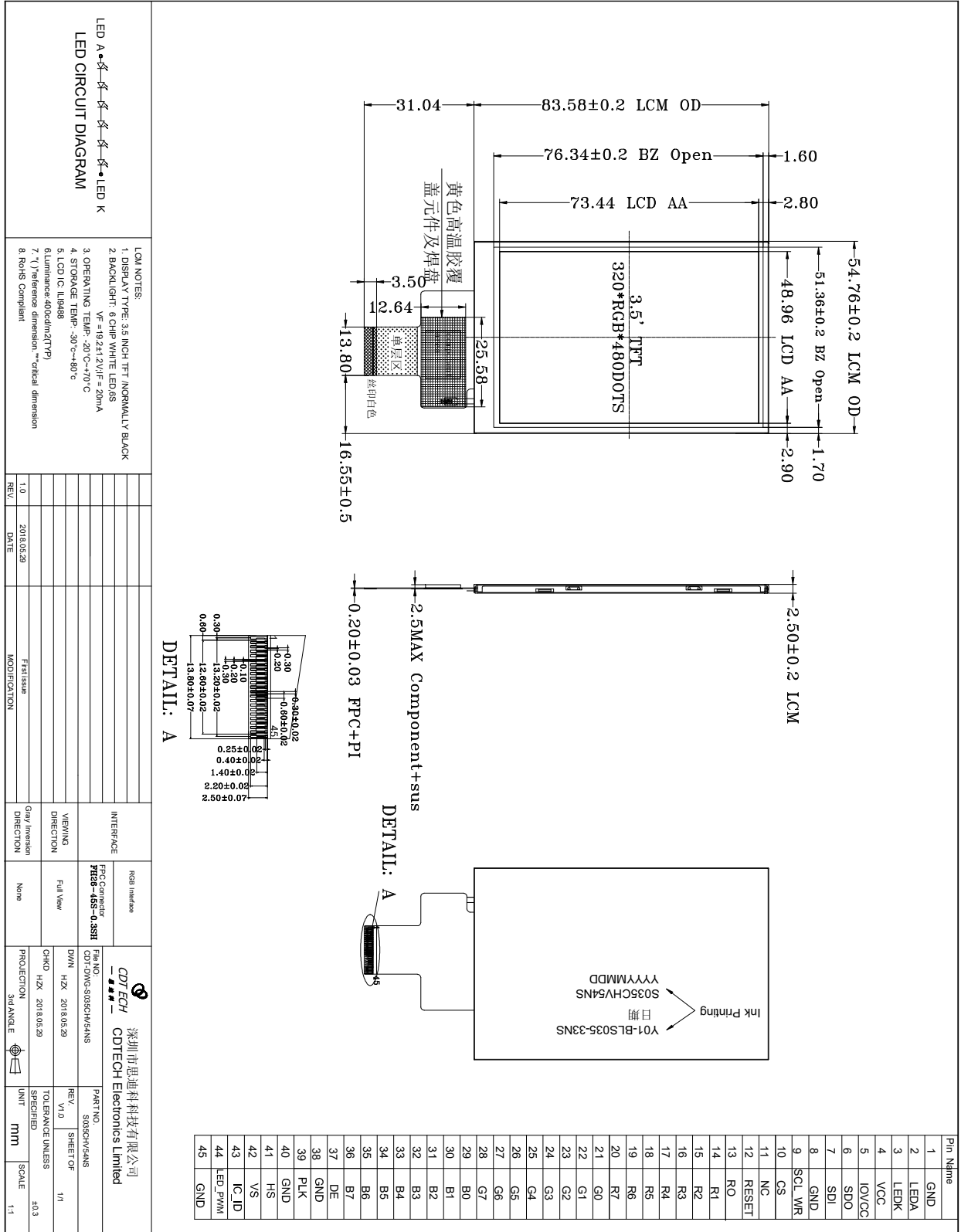



10 Packing

Packing Method

TBD

11. Precautions for Use of LCD modules

11.1 Handling Precautions

11.1.1. The display panel is made of glass. Do not subject it to a mechanical shock by dropping it from a high place, etc.

11.1.2. If the display panel is damaged and the liquid crystal substance inside it leaks out, be sure not to get any in your mouth, if the substance comes into contact with your skin or clothes, promptly wash it off using soap and water.

11.1.3. Do not apply excessive force to the display surface or the adjoining areas since this may cause the color tone to vary.

11.1.4. The polarizer covering the display surface of the LCD module is soft and easily scratched. Handle this polarizer carefully.

11.1.5. If the display surface is contaminated, breathe on the surface and gently wipe it with a soft dry cloth. If still not completely clear, moisten cloth with one of the following solvents:

- Isopropyl alcohol
- Ethyl alcohol

Solvents other than those mentioned above may damage the polarizer. Especially, do not use the following:

- Water
- Ketene
- Aromatic solvents

11.1.6. Do not attempt to disassemble the LCD Module.

11.1.7. If the logic circuit power is off, do not apply the input signals.

11.1.8. To prevent destruction of the elements by static electricity, be careful to maintain an optimum work environment.

11.1.8.1. Be sure to ground the body when handling the LCD Modules.

11.1.8.2. Tools required for assembly, such as soldering irons, must be properly ground.

11.1.8.3. To reduce the amount of static electricity generated, do not conduct assembly and other work under dry conditions.

11.1.8.4. The LCD Module is coated with a film to protect the display surface. Be care when peeling off this protective film since static electricity may be generated.

11.2 Storage Precautions

11.2.1. When storing the LCD modules, avoid exposure to direct sunlight or to the light of fluorescent lamps.

11.2.2. The LCD modules should be stored under the storage temperature range. If the LCD modules will be stored for a long time, the recommend condition is:

Temperature : 0°C ~ 40°C Relatively humidity: ≤80%

11.2.3. The LCD modules should be stored in the room without acid, alkali and harmful gas.



11.3 Transportation Precautions

The LCD modules should be no falling and violent shocking during transportation, and also should avoid excessive press, water, damp and sunshine.