

## Product Specification

<b>Model Name</b>	S070BWS45FD-DC85
<b>Description</b>	7.0" WSVGA 1024(RGB)x600 Dots
<b>Date</b>	2021/02/26
<b>Version</b>	1.0

<b>Approved by/Date</b>	<b>Check by/Date</b>	<b>Prepared by/Date</b>
ZHP 2021/02/26	HZX 2021/02/26	ZWF 2021/02/26

<b>Customer Approval</b>	
<b>Date</b>	

## Table of Contents

<b>1. Record of Revision .....</b>	<b>3</b>
<b>2. General Specifications .....</b>	<b>4</b>
<b>3. Input/Output Terminals .....</b>	<b>5</b>
<b>4. Absolute Maximum Rating .....</b>	<b>7</b>
<b>5. Electrical Characteristics.....</b>	<b>7</b>
<b>6. Interface Timing.....</b>	<b>9</b>
<b>7. Optical Characteristics .....</b>	<b>15</b>
<b>8. Environmental / Reliability Tests .....</b>	<b>18</b>
<b>9. Mechanical Drawing .....</b>	<b>19</b>
<b>10. Packing .....</b>	<b>20</b>
<b>11. Precautions for Use of LCD modules .....</b>	<b>21</b>

## 1. Record of Revision

Rev	Issued Date	Description	Editor
1.0	2021/02/26	First Release.	ZWF

## 2. General Specifications

	Feature	Spec
Characteristics	Size	7 inch
	Resolution	1024(horizontal)*600(Vertical)
	Interface	LVDS
	Connect type	Connector
	Display Colors	16.7M
	Technology type	a-Si
	Pixel pitch (mm)	0.150*0.143
	Pixel Configuration	R.G.B.-Stripe
	Display Mode	Normally Black
	LCD Driver IC	EK79001HN+EK73215BCGA
	CTP Driver IC	GT911
	Viewing Direction	Full view
Mechanical	LCM (W x H x D) (mm)	175.8*109.24*7.67
	Active Area(mm)	154.21 x85.92
	With /Without TSP	With CTP
	Weight (g)	TBD
	LED Numbers	30 LEDs

Note 1: Requirements on Environmental Protection: RoHs

Note 2: LCM weight tolerance: +/- 5%

## 3. Input/Output Terminals

### LCD PIN-MAP

No.	Symbol	Description
1	VCOM	Common Voltage
2	VDD	Power Voltage for digital circuit
3	VDD	Power Voltage for digital circuit
4	NC	No connection
5	RESET	Global reset pin
6	STBYB	Standby mode Normally pulled high STBYB=1,normal operation STBYB=0,timing contrller,source Driver will turn off,all output are High-Z
7	GND	Ground
8	RXIN0-	-LVDS differential data input
9	RXIN0+	+LVDS differential data input
10	GND	Ground
11	RXIN1-	-LVDS differential data input
12	RXIN1+	+LVDS differential data input
13	GND	Ground
14	RXIN2-	-LVDS differential data input
15	RXIN2+	+LVDS differential data input
16	GND	Ground
17	RXCLKIN-	-LVDS differential clock input
18	RXCLKIN+	+LVDS differential clock input
19	GND	Ground
20	RXIN3-	-LVDS differential data input
21	RXIN3+	+LVDS differential data input
22	GND	Ground
23	NC	No connection
24	NC	No connection
25	GND	Ground
26	NC	No connection
27	DIMO	Backlight CABC controller signal output
28	SELB	6bit/8bit mode select (Note 1)
29	AVDD	Power for Analog Circuit
30	GND	Ground
31	LED-	LED Cathode
32	LED-	LED Cathode

33	L/R	Horizontal inversion	(Note 2)
34	U/D	Vertical inversion	(Note 2)
35	VGL	Gate oFF Voltage	Power supply
36	NC	No connection	
37	NC	No connection	
38	VGH	Gate ON Voltage	
39	LED+	LED Anode	
40	LED+	LED Anode	

Note 1: if LVDS input data is 6bit,selb must be set to high;

if LVDS input data is 8bit,selb must be set to low;

Note 2: when L/R=0 set right to left scan direction

when L/R=1 set left to right scan direction

when U/D=0 set top to bottom scan direction

when U/D=1 set bottom to top scan direction

## CTP PIN-MAP

Pin	Signal	Description
1	GND	Ground
2	VDD	Power supply
3	SDA	I2C data input and output
4	SCL	I2C clock input
5	RST	Reset Pin for CTP
6	INT	Interrupt request to the host
7	Test-NC	No connection
8	VSS-GND	Ground

## 4. Absolute Maximum Rating

Item	Symbol	MIN	Typ	MAX	Unit	Remark
Supply Voltage	VDD	-0.3	-	5	V	-
Operating Temperature	TOPR	-20	-	70	°C	-
Storage Temperature	TSTG	-30	-	80	°C	-

## 5. Electrical Characteristics

### 5.1 Driving TFT LCD Panel

Item	Symbol	MIN	TYP	MAX	Unit	Remark
Power supply for LCD	VDD	3.0	3.3	3.6	V	
	AVDD	9.0	9.8	10.5	V	
	VGH	16.0	18.0	20	V	
	VGL	-7.5	-6.0	-5.0	V	
	VCOM	2.9	3.25	3.5	V	

### 5.2 CTP Electrical Characteristics

FPC Design	Item	Description	Remark
COF	IC solution on TP Model	GT911	
	Touch Count Max	5 point	
	Display Resolution	1024*600	
	Interface Type	I2C	
	I2C Slave Address	OX28	
	Origin of Coordinate	Top left corner	

Parameter	Min	Typ	Max	Unit
Interface Signal Voltage	-	2.8	-	V
Power Voltage	VDD	3.3	-	V

### 5.3 LED Driving Conditions

Item	Symbol	MIN	TYP	MAX	Unit	Remark
Forward Current	$I_F$	-	300	-	mA	
Forward Voltage	$V_F$	8.1	-	10.2	V	
Backlight Power consumption	$W_{BL}$	2.43	-	3.06	W	
LED Lifetime		-	50000	-	Hrs	

Note 1: Each LED:  $I_F = 30\text{ mA}$ ,  $V_F = 2.8\sim 3.4\text{V}$ .

Note 2: Optical performance should be evaluated at  $T_a = 25^\circ\text{C}$  only.

Note 3: If LED is driven by high current, high ambient temperature & humidity condition. The life Time of LED will be reduced. Operating life means brightness goes down to 50% initial brightness. Typical operating life time is estimated data.

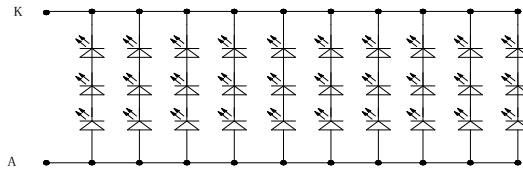

Figure: LED connection of backlight(Constant Current)



## 6. Interface Timing

### 6.1 Power sequence

#### a. Power on:

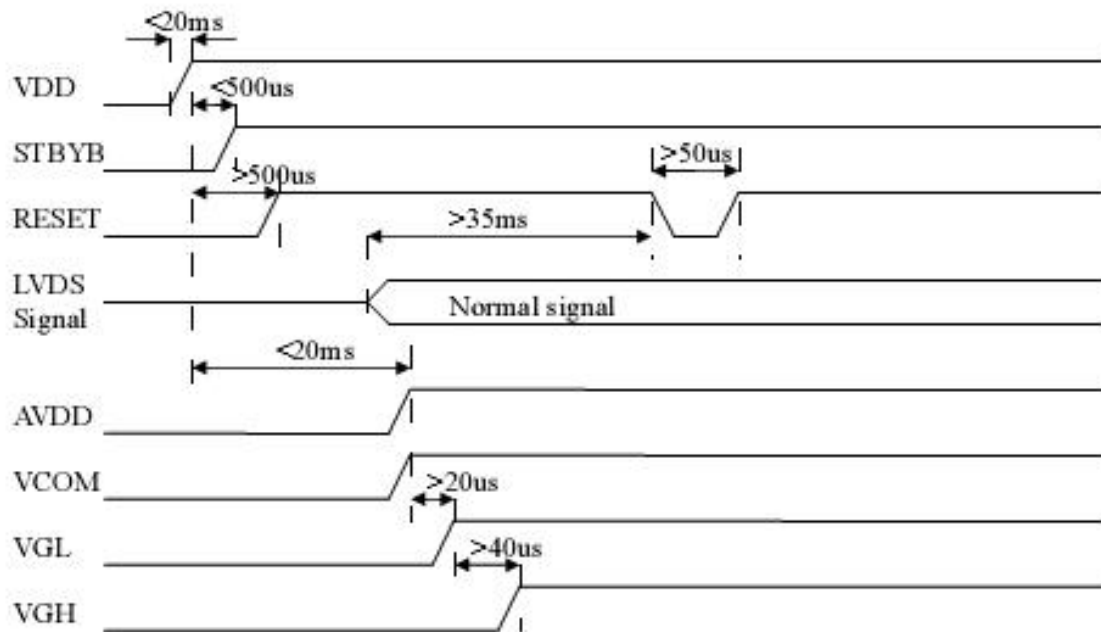

#### b. Power off:

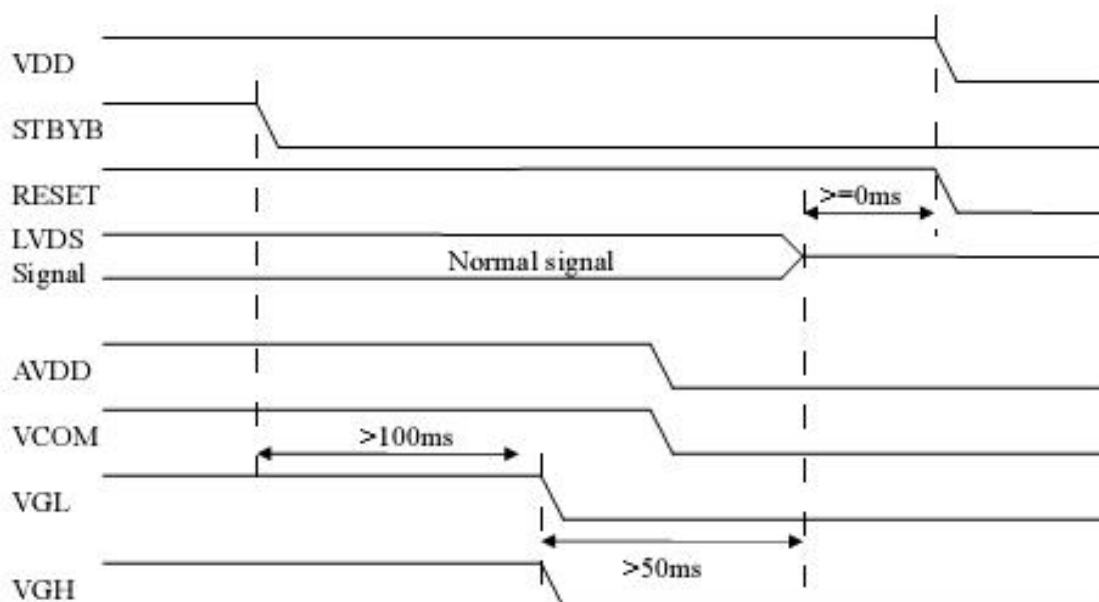

## 6.2 Timing Characteristics

### 3.3.1. AC Electrical Characteristics

Parameter	Symbol	Values			Unit	Remark
		Min.	Typ.	Max.		
Clock frequency	$R_{XFCLK}$	40.8	51.2	67.2	MHz	
Input data skew margin	$T_{RSKM}$	500	-	-	ps	
Clock high time	$T_{LVCH}$	-	$4/(7 * R_{XFCLK})$	-	ns	
Clock low time	$T_{LVCL}$	-	$3/(7 * R_{XFCLK})$	-	ns	

### 3.3.2. Input Clock and Data Timing Diagram

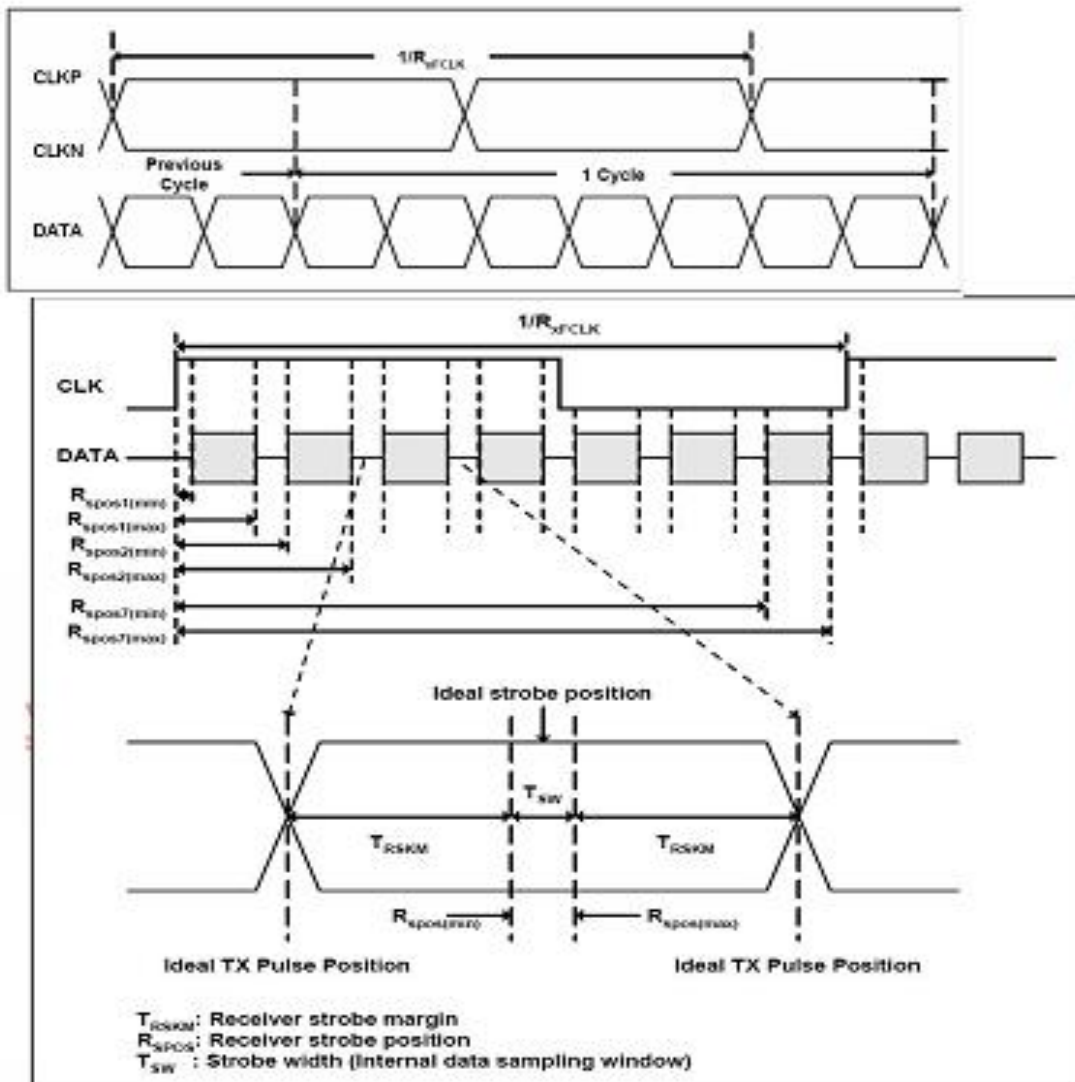

### 3.3.3. DC Electrical Characteristics

Parameter	Symbol	Values			Unit	Remark
		Min.	Typ.	Max.		
Differential input high Threshold voltage	$R_{xVTH}$	-	-	+0.1	V	$R_{xVCM}=1.2V$
Differential input low Threshold voltage	$R_{xVTL}$	-0.1	-	-	V	
Input voltage range (singled-end)	$R_{xVIN}$	0	-	2.4	V	
Differential input common mode voltage	$R_{xVCM}$	$ V_{ID} /2$	-	$2.4- V_{ID} /2$	V	
Differential voltage	$ V_{ID} $	0.2	-	0.6	V	
Differential input leakage current	$R_{V_{xIZ}}$	-10	-	+10	$\mu A$	

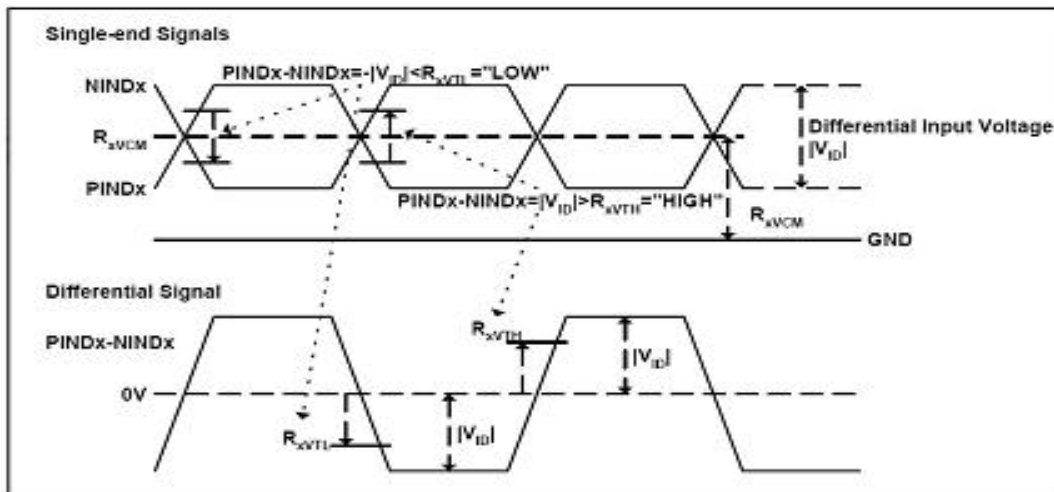

### 3.3.4. Timing

Item	Symbol	Values			Unit	Remark
		Min.	Typ.	Max.		
Clock Frequency	fclk	40.8	51.2	67.2	MHz	Frame rate =60Hz
Horizontal display area	thd	1024			DCLK	
HS period time	th	1114	1344	1400	DCLK	
HS Blanking	thb	90	320	376	DCLK	
Vertical display area	tvd	600			H	
VS period time	tv	610	635	800	H	
VS Blanking	thb	10	35	200	H	

## 3.3.5. Data Input Format

### 6bit LVDS input

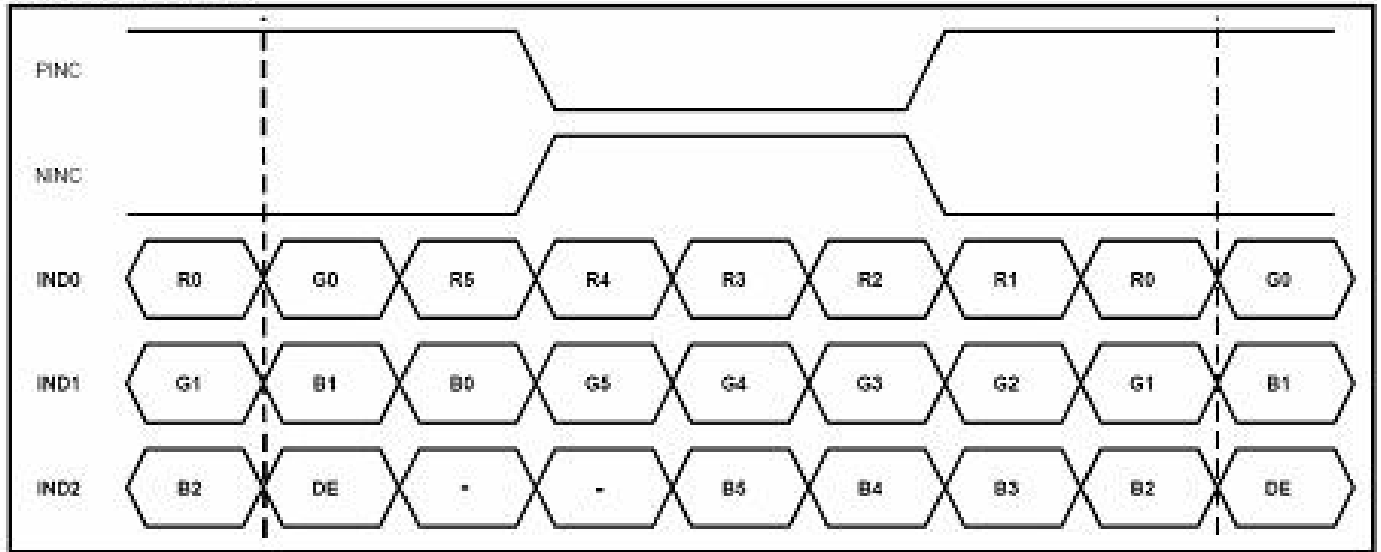

### 8bit LVDS input

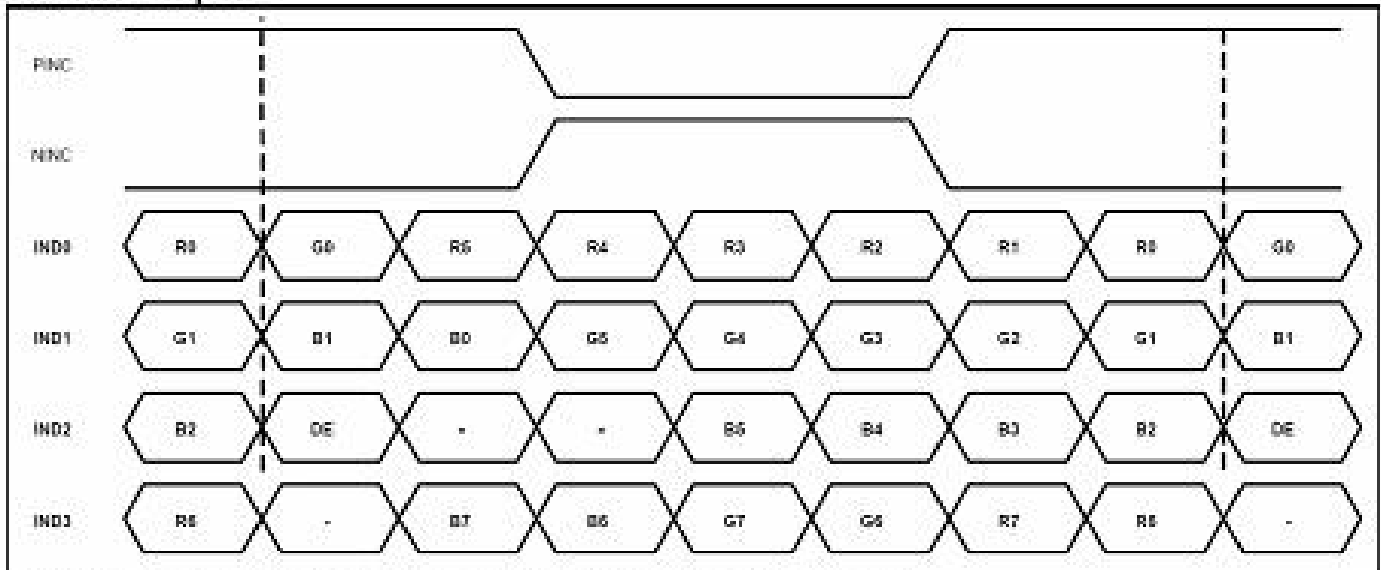

Note: Support DE timing mode only, SYNC mode not supported.

## 6.3 Capacitive touch panel Specification

### I2C

The I2C is always configured in the Slave mode. The data transfer format is shown in [Figure 2-4](#).

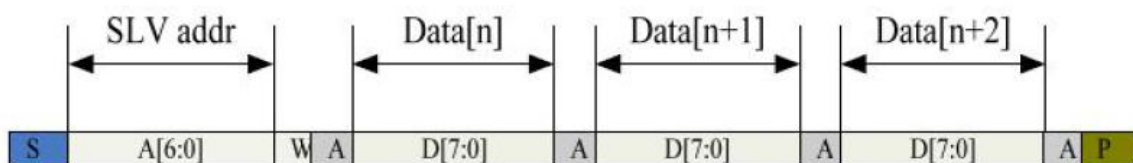
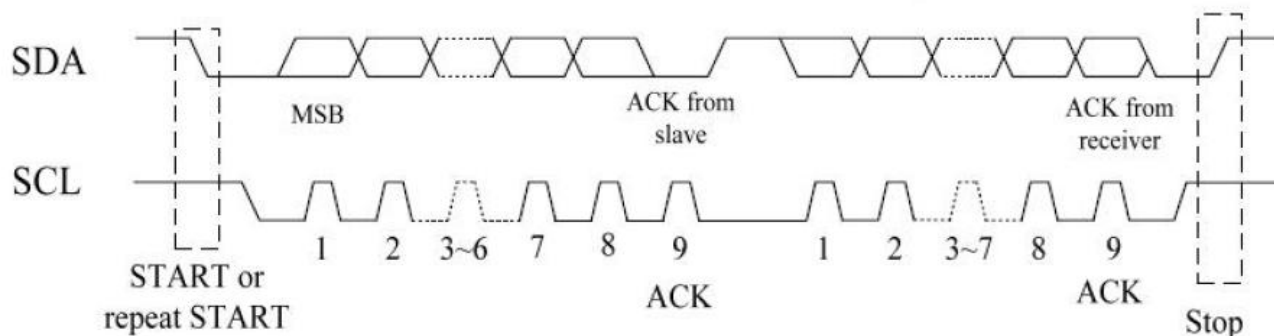

Figure 2-5 I2C master write, slave read

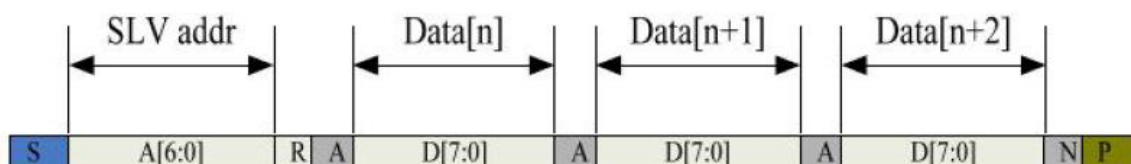

Figure 2-6 I2C master read, slave write

Table 2-1 lists the meanings of the mnemonics used in the above figures.

Table 2-1 Mnemonics Description

Mnemonics	Description
S	I2C Start or I2C Restart
A[6:0]	Slave address A[6:4]: 3'b011 A[3:0]: data bits are identical to those of I2CCON[7:4] register.
W	1'b0: Write
R	1'b1: Read
A(N)	ACK(NACK)
P	STOP: the indication of the end of a packet (if this bit is missing, S will indicate the end of the current packet and the beginning of the next packet)

I2C Interface Timing Characteristics is shown in Table 2-2.

Table 2-2 I2C Timing Characteristics

Parameter	Unit	Min	Max
SCL frequency	KHz	0	400
Bus free time between a STOP and START condition	us	4.7	\
Hold time (repeated) START condition	us	4.0	\
Data setup time	ns	250	\
Setup time for a repeated START condition	us	4.7	\
Setup Time for STOP condition	us	4.0	\

## 7. Optical Characteristics

Items	Symbol	Condition	Min.	Typ.	Max.	Unit	Remark	Note
Response time	Tr+Tf	-	-	30	40	ms	FIG.1	Note4
Contrast Ratio	CR		500	800	-	-	FIG.2	Note1
Surface luminance	LV	$\theta = 0^\circ$	900	1000	-	cd/m2	FIG.2	Note2
Luminance uniformity	Yu	$\theta = 0^\circ$	70	75	-	%	FIG.2	Note3
NTSC	-	$\theta = 0^\circ$	-	50	-	%	FIG.2	Note5
Viewing angle	$\theta_T$	Center CR $\geq$ 10	-	85	-	deg	FIG.3	Note6
	$\theta_B$		-	85	-	deg	FIG.3	
	$\theta_L$		-	85	-	deg	FIG.3	
	$\theta_R$		-	85	-	deg	FIG.3	
Chromaticity	Red	$R_X$	0.549	0.599	0.649	-	FIG.2 CIE1931	Note5
		$R_Y$	0.288	0.338	0.388	-		
	Green	$G_X$	0.249	0.299	0.349	-		
		$G_Y$	0.500	0.550	0.600	-		
	Blue	$B_X$	0.089	0.139	0.189	-		
		$B_Y$	0.081	0.131	0.183	-		
	White	$W_X$	0.258	0.308	0.358	-		
		$W_Y$	0.286	0.336	0.386	-		

### Note1. Definition of contrast ratio

Contrast ratio(Cr) is defined mathematically by the following formula. For more information see FIG.2.

$$\text{Contrast ratio} = \frac{\text{Luminance measured when LCD on the "White" state}}{\text{Luminance measured when LCD on the "Black" state}}$$

For contrast ratio, Surface Luminance, Luminance uniformity and CIE, the testing data is based on TOPCON's BM-5 or BM-7 photo detector or compatible.

### Note2. Definition of surface luminance.

Surface luminance is the luminance with all pixels displaying white. For more information see FIG.2.

$L_v$  = Average Surface Luminance with all white pixels( $P_1, P_2, P_3, \dots, P_n$ )

### Note3. Definition of luminance uniformity

The luminance uniformity in surface luminance is determined by measuring luminance at each test position 1 through n, and then dividing the maximum luminance of n points luminance by minimum luminance of n points luminance. For more information see FIG.2.

$$YU = \frac{\text{Minimum surface luminance with all white pixels } (P_1, P_2, P_3, \dots, P_n)}{\text{Maximum surface luminance with all white pixels } (P_1, P_2, P_3, \dots, P_n)}$$

### Note4. Definition of response time

The response time is defined as the LCD optical switching time interval between "White" state and "Black" state. Rise time ( $T_r$ ) is the time between photo detector output intensity changed from 90% to 10%. And

fall time (Tf) is the time between photo detector output intensity changed from 10% to 90%.

For additional information see FIG1.

**Note5. Definition of color chromaticity (CIE1931)**

CIE (x,y) chromaticity, The x,y value is determined by screen active area center position P5. For more information see FIG.2.

**Note6. Definition of viewing angle**

Viewing angle is the angle at which the contrast ratio is greater than 10. Angles are determined for the horizontal or x axis and the vertical or y axis with respect to the z axis which is normal to the LCD surface. For more information see FIG.3.

For viewing angle and response time testing, the testing data is base on Autronic-Melchers' s ConoScope or DMS series Instruments or compatible.

**FIG.1. The definition of response Time**

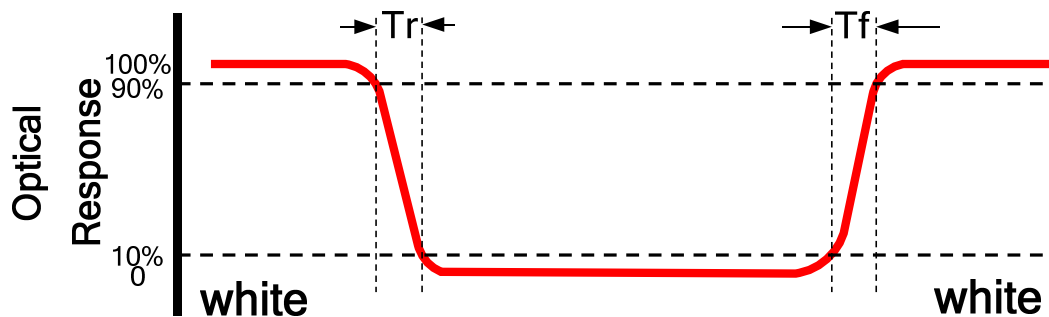

**FIG.2. Measuring method for contrast ratio, surface luminance, luminance uniformity, CIE (x,y) chromaticity**

Size : S≤5" (see Figure a) A : 5 mm B : 5 mm  
H, V : Active area

Light spot size  $\varnothing=5\text{mm}$  (BM-5) or  $\varnothing=7.7\text{mm}$  (BM-7) 50cm distance or compatible distance from the LCD surface to detector lens.

test spot position : see Figure a.

measurement instrument : TOPCON's luminance meter BM-5 or BM-7 or compatible (see Figure c).

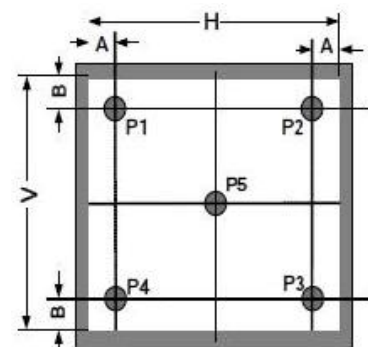

Figure a

Size : 5" < S ≤ 12.3" (see Figure b) H, V : Active area

Light spot size  $\varnothing=5\text{mm}$  (BM-5) or  $\varnothing=7.7\text{mm}$  (BM-7) 50cm distance or compatible distance from the LCD surface to detector lens.

test spot position : see Figure b.

measurement instrument : TOPCON's luminance meter BM-5 or BM-7 or compatible (see Figure c).

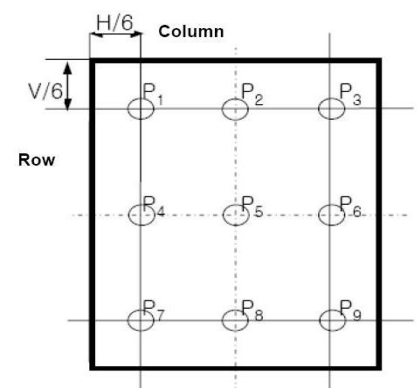

Figure b



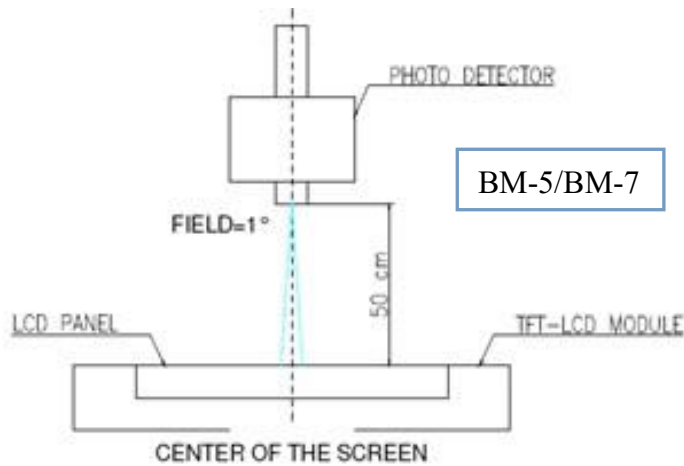
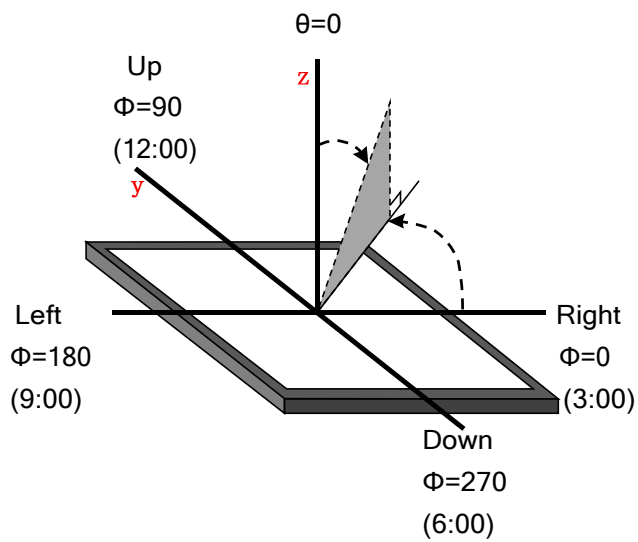

Figure c

FIG.3.The definition of viewing angle



## 8. Environmental / Reliability Tests

No	Test Item	Condition	Remarks
1	High Temperature Operation	Ts= +70°C, 96hrs	Note 1 IEC60068-2-2, GB2423. 2-89
2	Low Temperature Operation	Ta= -20°C, 96hrs	Note 2 IEC60068-2-1 GB2423.1-89
3	High Temperature Storage	Ta= +80°C, 96hrs	IEC60068-2-2 GB2423. 2-89
4	Low Temperature Storage	Ta= -30°C, 96hrs	IEC60068-2-1 GB/T2423.1-89
5	High Temperature & Humidity Storage	Ta= +60°C, 90% RH max,96 hours	IEC60068-2-3 GB/T2423.3-2006
6	Thermal Shock (Non-operation)	-20°C 30 min ~ +60°C 30 min Change time: 5min, 30 Cycle	Start with cold temperature, end with high temperature IEC60068-2-14, GB2423.22-87
7	Electro Discharge (Operation)	Static C=150pF, R=330 Ω, 5 points/panel Air:±8KV, 5 times; Contact: ±4KV, 5 times; (Environment: 15°C ~ 35°C, 30% ~ 60%, 86Kpa ~ 106Kpa)	IEC61000-4-2 GB/T17626.2-1998
8	Vibration (Non-operation)	Frequency range: 10~55Hz, Stroke: 1.mm Sweep: 10Hz~55Hz~10Hz 2 hours for each direction of X .Y. Z. (package condition)	IEC60068-2-6 GB/T2423.5-1995
9	Shock (Non-operation)	60G 6ms, ± X, ±Y , ± Z 3 times for each direction	IEC60068-2-27 GB/T2423.5-1995
10	Package Drop Test	Height: 80 cm, 1 corner, 3 edges, 6 surfaces	IEC60068-2-32 GB/T2423.8-1995

Note: 1. Ts is the temperature of panel's surface.

2. Ta is the ambient temperature of sample.

3. The size of sample is 5pcs.

## 9. Mechanical Drawing

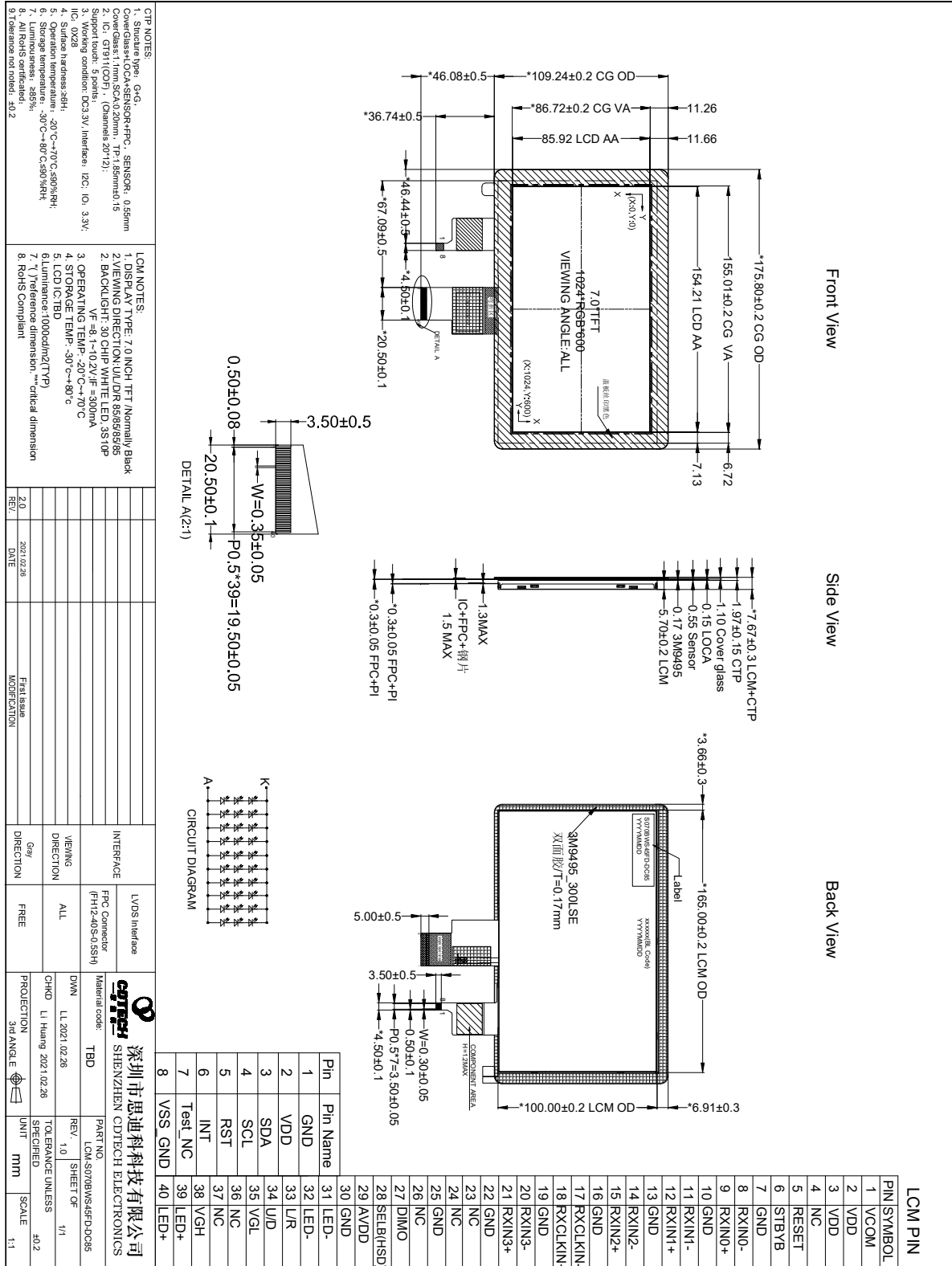

## 10. Packing

### Packing Method

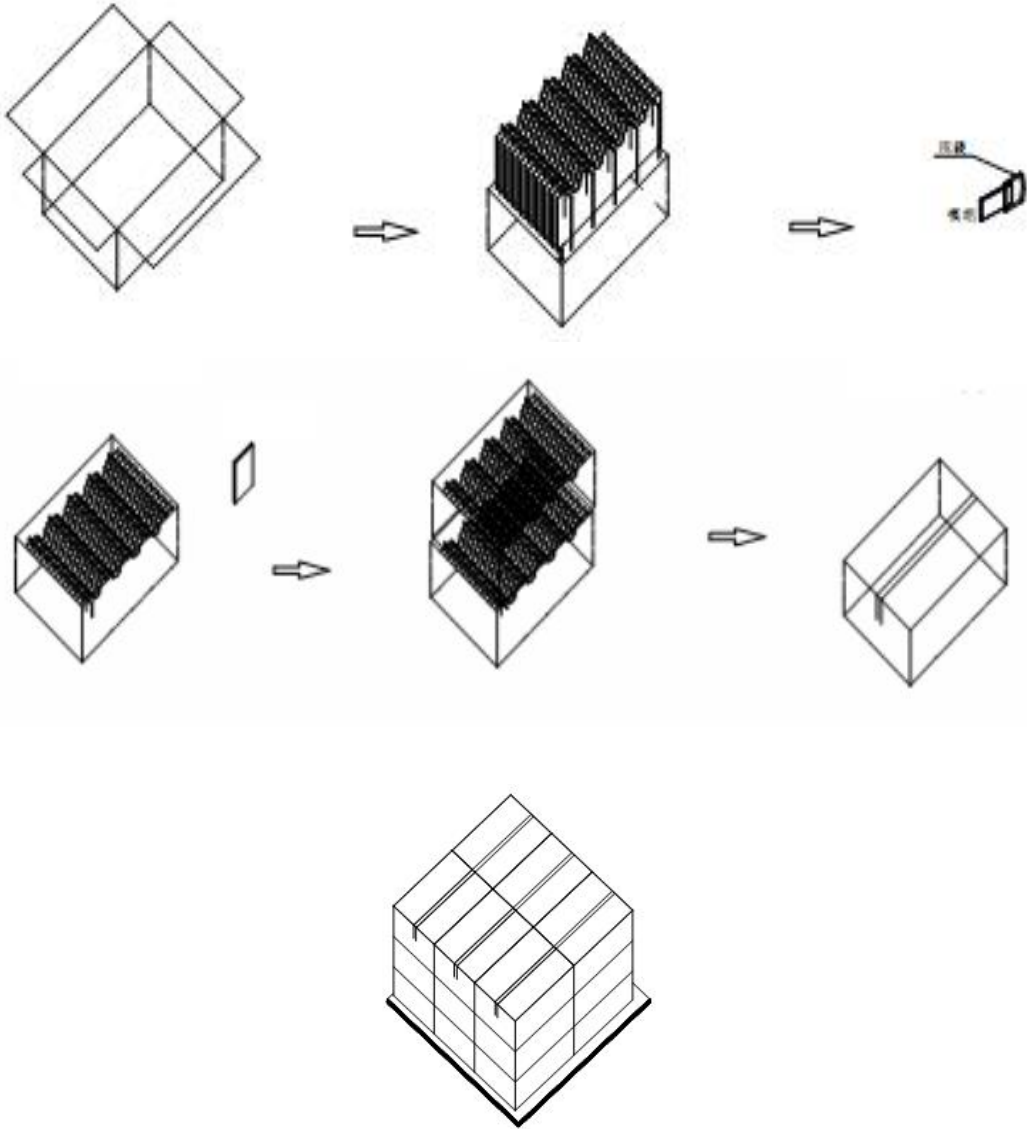

## 11. Precautions for Use of LCD modules

### 11.1 Handling Precautions

11.1.1. The display panel is made of glass. Do not subject it to a mechanical shock by dropping it from a high place, etc.

11.1.2. If the display panel is damaged and the liquid crystal substance inside it leaks out, be sure not to get any in your mouth, if the substance comes into contact with your skin or clothes, promptly wash it off using soap and water.

11.1.3. Do not apply excessive force to the display surface or the adjoining areas since this may cause the color tone to vary.

11.1.4. The polarizer covering the display surface of the LCD module is soft and easily scratched. Handle this polarizer carefully.

11.1.5. If the display surface is contaminated, breathe on the surface and gently wipe it with a soft dry cloth. If still not completely clear, moisten cloth with one of the following solvents:

- Isopropyl alcohol
- Ethyl alcohol

Solvents other than those mentioned above may damage the polarizer. Especially, do not use the following:

- Water
- Ketene

11.1.6. Do not attempt to disassemble the LCD Module.

11.1.7. If the logic circuit power is off, do not apply the input signals.

11.1.8. To prevent destruction of the elements by static electricity, be careful to maintain an optimum work environment.

11.1.8.1. Be sure to ground the body when handling the LCD Modules.

11.1.8.2. Tools required for assembly, such as soldering irons, must be properly ground.

11.1.8.3. To reduce the amount of static electricity generated, do not conduct assembly and other work under dry conditions.

11.1.8.4. The LCD Module is coated with a film to protect the display surface. Be care when peeling off this protective film since static electricity may be generated.

### 11.2 Storage Precautions

11.2.1. When storing the LCD modules, avoid exposure to direct sunlight or to the light of fluorescent lamps.

11.2.2. The LCD modules should be stored under the storage temperature range. If the LCD modules will be stored for a long time, the recommend condition is:

Temperature : 0°C ~ 40°C      Relatively humidity: ≤80%

11.2.3. The LCD modules should be stored in the room without acid, alkali and harmful gas.

### 11.3 Transportation Precautions

The LCD modules should be no falling and violent shocking during transportation, and also should avoid excessive press, water, damp and sunshine.