



PRODUCT SPECIFICATION

CDTECH Model: **S088AWX22EB-DC08**

CUSTOMER Model: **-**

Description: **8.8" TFT-LCD Module with CTP**

Version: **1.0**

CDTECH	PREPARED BY	CHECKED BY	APPROVED BY
SIGNATURE			
DATE	2023.7.8	2023.7.8	2023.7.8

CUSTOMER APPROVAL	SIGNATURE	DATE



Contents

1. General Specifications	4
2. Absolute Maximum Ratings	5
3. Electrical Characteristics	5
4. Interface Pin Assignment	7
5. Interface Characteristics	9
6. Optical Specifications	17
7. Reliability Test Items	20
8. Mechanical Drawing	21
9. Packing	错误! 未定义书签。
10. Precautions for Use of LCD modules	23

1. General Specifications

1.1 LCM General Information

Item	Specification	Unit
LCD Size	8.8	inch
Number of Pixels	1280 (H) RGB x 320 (V)	pixels
Display Mode	Normally Black	-
Viewing Direction	Free	o' clock
Interface	LVDS	-
Display Colors	16.7M	colors
Outline Dimension	229.66 (H) x 67.50 (V) x 5.65 (D)	mm
Active Area	216.96 (H) x 54.24 (V)	mm
Pixel Pitch	0.1695 (H) x 0.1695 (V)	mm
Driver IC	EK79202	-
Operation Temperature	-20~70	°C
Storage Temperature	-30~80	°C

1.2 Touch Panel Information

Item	Specification
Touch Structure	G+G
Bonding Type with LCM	Perimeter Bonding
Driver IC	GT928
Interface	I ² C
Touch Count Max	10 Points
Surface treatment	-
Surface hardness	6H
I2C slave address	0x28
Origin of coordinate	Top Left Corner

Note1: Requirements on environmental protection RoHS compliant.

2. Absolute Maximum Ratings

Item	Symbol	MIN.	MAX.	Unit	Note
Analog Supply voltage	VDD	-0.3	5.0	V	Note 1

Note 1: Permanent damage may occur to the LCD module if beyond this specification.

Functional operation should be restricted to the conditions described under normal operating conditions.

3. Electrical Characteristics

3.1 Recommended Operating Condition for TFT LCD

Item	Symbol	Min.	Typ.	Max.	Unit	Note
Analog Supply voltage	VDD	3.0	3.3	3.6	V	
Analog supply current	I _{VDD}	235	340	445	mA	VDD=3.3V (White)
Logic input voltage	V _{IH}	0.7*VDD	-	VDD	V	
	V _{IL}	GND	-	0.3*VDD	V	

3.2 Recommended Driving Condition for Backlight

Item	Symbol	Min.	Typ.	Max.	Unit	Note
Driving Current	I _F	-	180	-	mA	
Driving Voltage	V _F	21.6	-	27.2	V	
Power consumption	W _{BL}	3.888	-	4.896	W	
LED Life-Time	N/A	-	50,000	-	Hours	T _a =25°C Note 1

Note 1: LED lifetime is defined as the module brightness decay 50% of original brightness at T_a=25 degree, typical current.

Note 2:LED circuit :

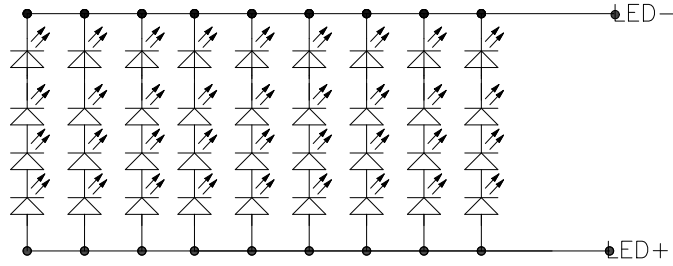

3.3 Touch Panel

Item	Symbol	Min.	Typ.	Max.	Unit	Note
Power Supply voltage	VCC	-	3.3	-	V	
Analog supply current	I _{VCC}	10	15	20	mA	VCC=3.3V
Input high-level voltage	V _{IH}	0.7*VCC	-	VCC	V	
Input low -level voltage	V _{IL}	GND	-	0.3*VCC	V	

4. Interface Pin Assignment

4.1 LCM Pin Assignment

Recommended connector: FH12-40S-0.5SH manufactured by HIROSE

No.	Symbol	Description
1	NC	No connection
2-3	VDD	Power Supply
4	NC	No connection
5	RESET	Global reset pin
6	STBYB	Standby mode Normally pulled high STBYB=1,normal operation STBYB=0,timing contrller,source Driver will turn off,all output are High-Z
7	GND	Ground
8	RXIN0-	- LVDS differential data input
9	RXIN0+	+ LVDS differential data input
10	GND	Ground
11	RXIN1-	- LVDS differential data input
12	RXIN1+	+ LVDS differential data input
13	GND	Ground
14	RXIN2-	- LVDS differential data input
15	RXIN2+	+ LVDS differential data input
16	GND	Ground
17	RXCLK-	-LVDS differential clock input
18	RXCLK+	+LVDS differential clock input
19	GND	Ground
20	RXIN3-	- LVDS differential data input
21	RXIN3+	+ LVDS differential data input
22	GND	Ground
23	SDA	Serial data input/output signal
24	SCL	Serial clock signal
25	GND	Ground
26	CS	Chip select pin
27	NC	No connection

28	LVBIT	6-bit / 8-bit input select for LVDS mode
29	NC	No connection
30	GND	Ground
31-32	LEDK-	Power for LED backlight (Cathode)
33-38	NC	No connection
39-40	LEDA+	Power for LED backlight (Anode)

4.2 Touch FPC Pin Assignment

No.	Symbol	Description
1	SCL 1.8V	I2C clock input (1.8V)
2	SDA 1.8V	I2C data input and output (1.8V)
3	GND	Ground
4	RST 1.8V	Wake-up request from the host (1.8V)
5	INT 1.8V	Interrupt request to the host (1.8V)
6	VCC 3.3V	Power supply (3.3V)
7	NC	No connection
8	GND	Ground
9	NC	No connection
10	GND	Ground

5. Interface Characteristics

5.1 LVDS Interface

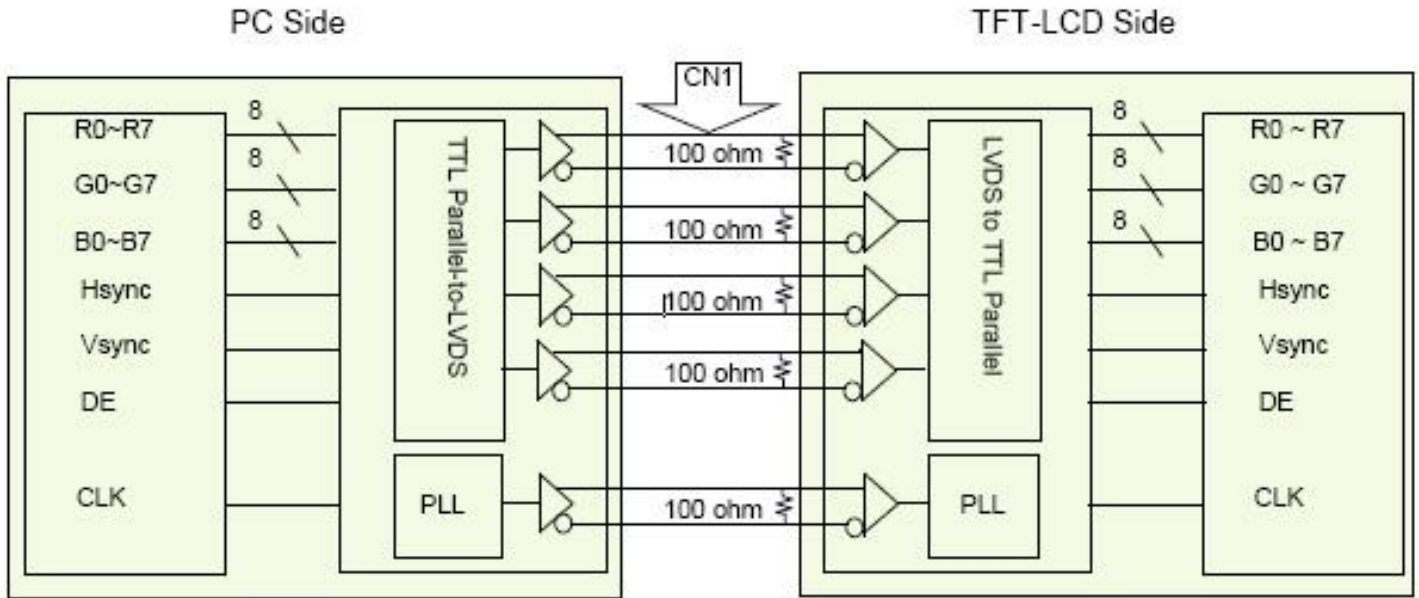

5.2 LVDS mode AC Electrical Characteristics

Parameter	Symbol	Spec.			Unit	Condition
		Min.	Typ.	Max.		
Clock frequency	R_{XFCLK}	30	-	TBD	MHz	Refer to input timing table for each display resolution
Input data skew margin	T_{RSKM}	500	-	-	ps	$ VID = 200mV$ $R_{xVCM} = 1.2V$ $R_{xFCLK} = 81MHz$
Clock high time	T_{LVCH}	-	$4/(7 * R_{XFCLK})$	-	ns	
Clock low time	T_{LVCL}	-	$3/(7 * R_{XFCLK})$	-	ns	
PLL wake-up time	T_{enPLL}	-	-	150	us	

Table 13.1: LVDS mode AC electrical characteristics

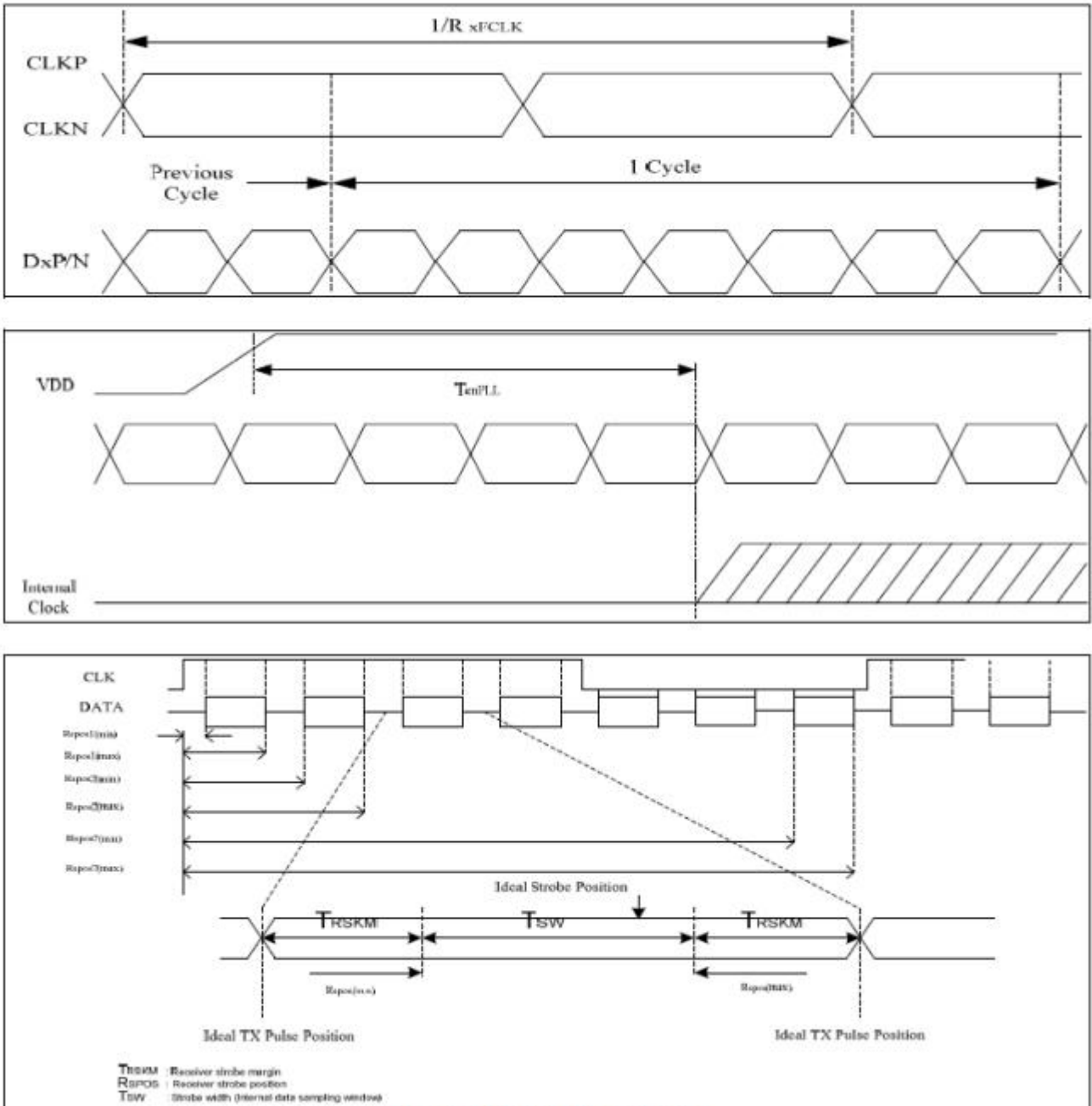

Figure 13.3: LVDS figure

5.3 LVDS DC Electrical Characteristics

(VDD=VDDIO=VDDIF=2.3 to 3.6V, VSS=VSSA=VSS_IF=0V, TA=-20 to +85°C)

Parameter	Symbol	Min.	Typ.	Max.	Unit	Condition
Differential input high threshold voltage	R _{XVTH}	+0.1	0.2	0.3	V	R _{XVCM} =1.2V
Differential input low threshold voltage	R _{XVTL}	-0.3	-0.2	-0.1	V	
Input voltage range (singled-end)	R _{XVIN}	0.7	-	1.7	V	
Differential input common mode voltage	R _{XVCM}	1	1.2	1.4	V	V _{ID} =0.2
Differential input impedance	Z _{ID}	80	100	125	ohm	
Differential input voltage	V _{ID}	0.2	-	0.6	V	
Differential input leakage current	I _{LCLVDS}	-10	-	+10	uA	
LVDS Digital Operating Current	I _{VDDMIPI}	-	15	20	mA	F _{DCLK} =80MHz, VDD=3.3V, Input pattern: 55h->Aah->55h->Aah
LVDS Digital Stand-by Current	I _{STMIPI}	-	-	250	uA	Clock & all Functions are stopped

Single-end Signals

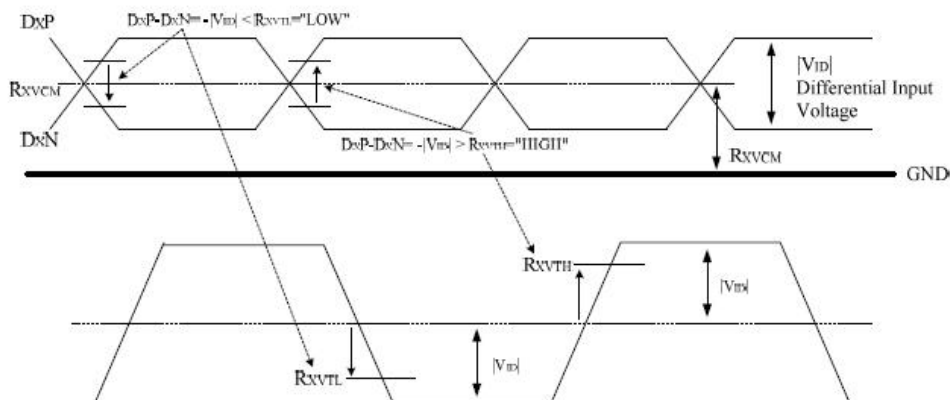

5.4 Timing

Item	Symbol	Min.	Typ.	Max.	Unit	
Frame Rate	-	-	60	-	Hz	
PCLK Frequency	FPCLK	-	31	-	MHz	
Horizontal	Ttotal line	TH	-	1440	-	DCLK
	Active pixels	THD	1280			DCLK
	Back porch	HBP		87	-	DCLK
	Pulse width	HPW	-	1	-	DCLK
	Front porch	HFP		72	-	DCLK
Vertical	Total time	TV	-	358	-	H
	Active lines	VD	320			H
	Back porch	VBP	-	22	-	H
	Pulse width	VPW	-	1	-	H
	Front porch	VFP	-	15	-	H

5.5 Data input format for LVDS

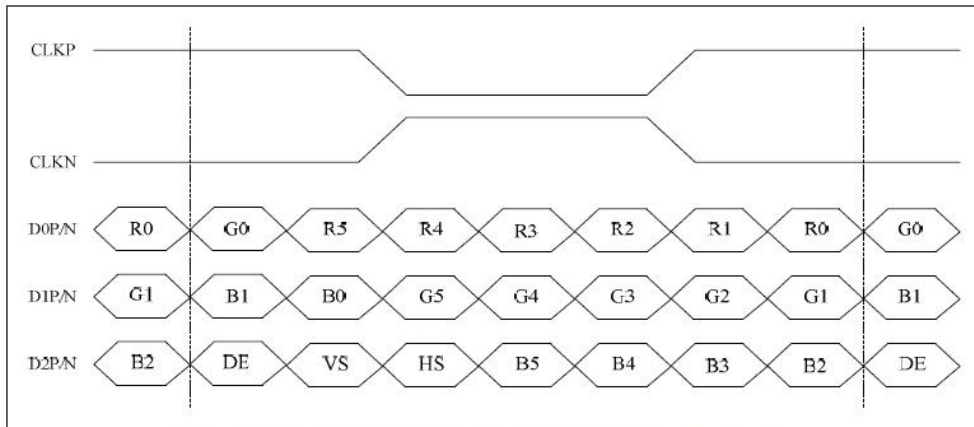

6-bit LVDS input (LVBIT=L, LVFMT=Don't care)

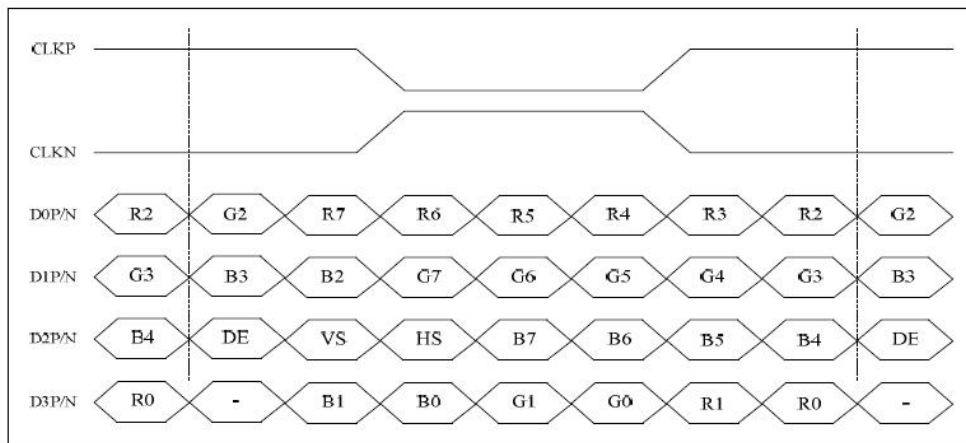

8-bit LVDS input (LVBIT=H, LVFMT=L)

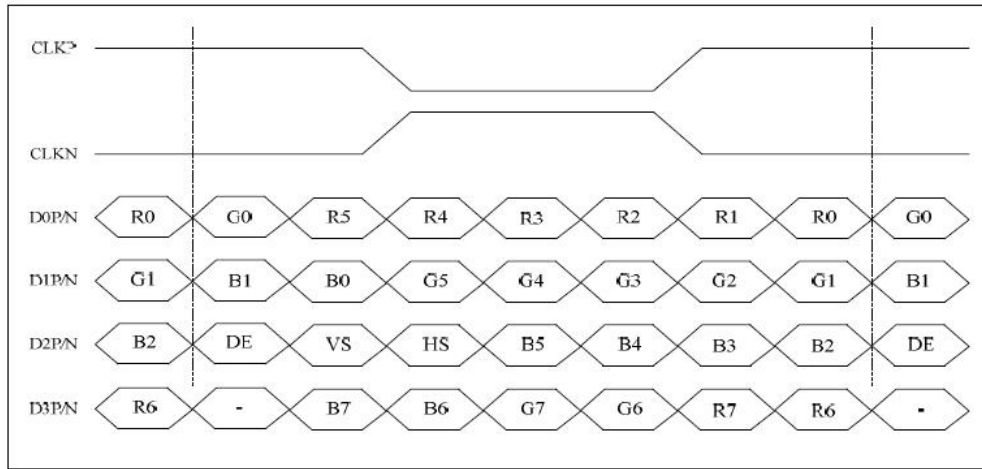

8-bit LVDS input(LVBIT=H, LVFMT=H)

5.6 Power Sequence

5.6.1 Power on Sequence

External VSP/VSN External VGH/VGL

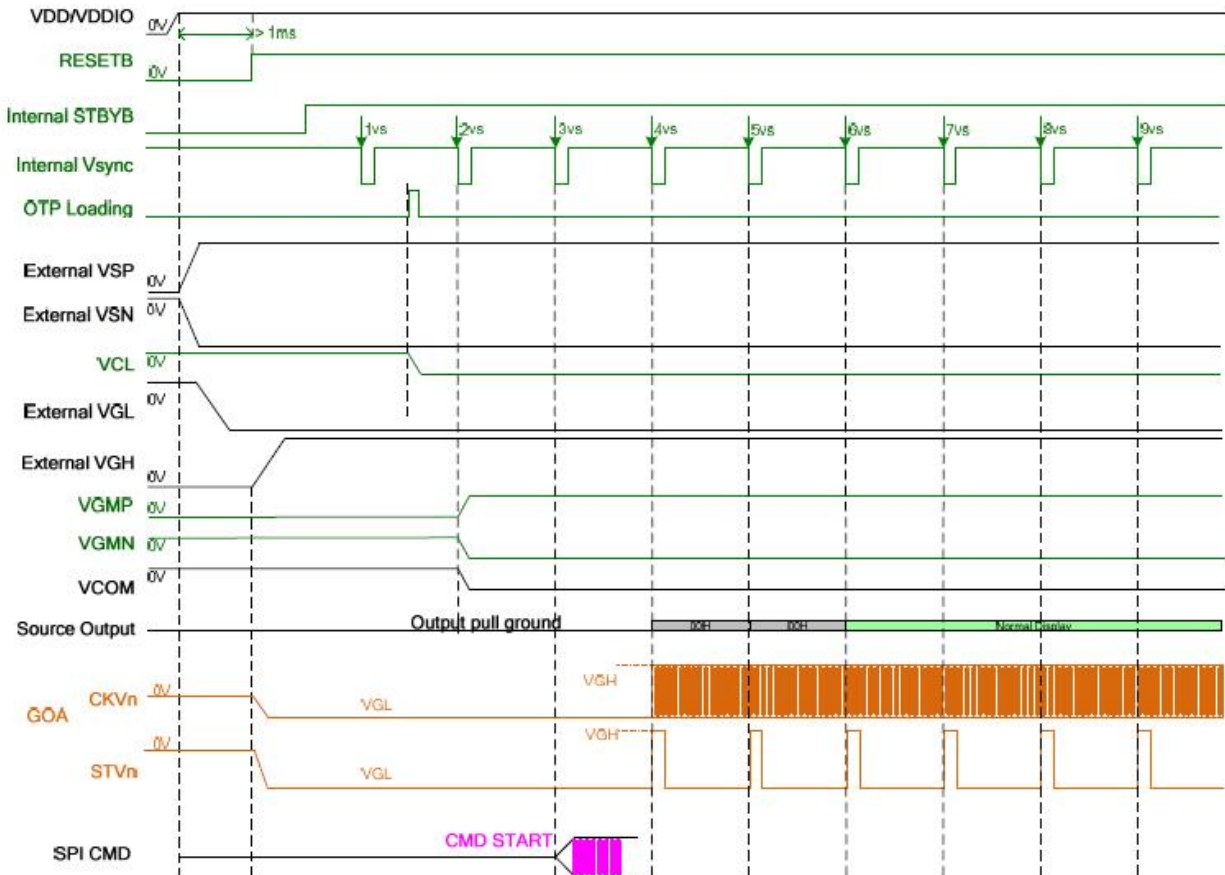

5.6.2 Power off Sequence

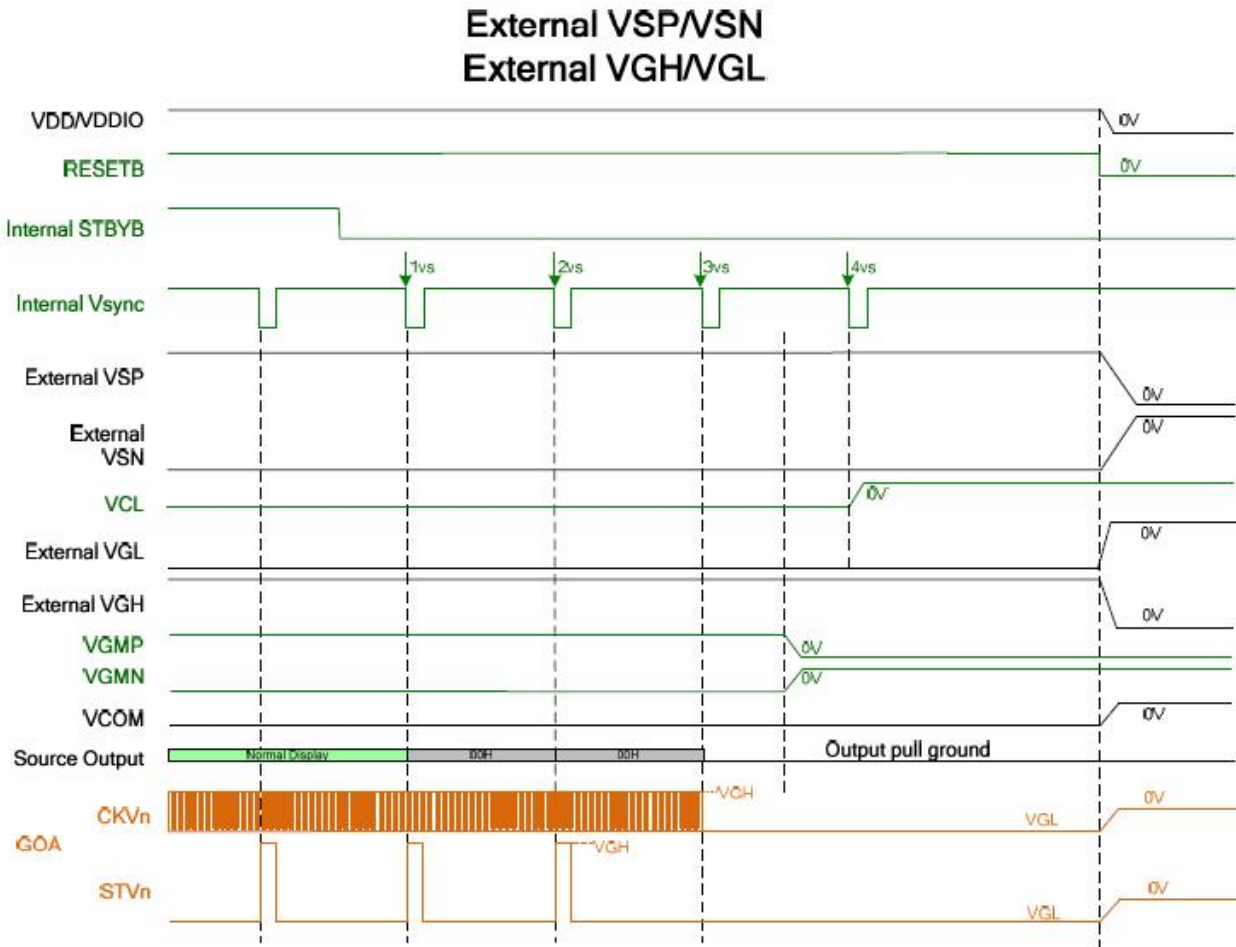

5.7 Capacitive touch panel Specification

I2C

The I2C is always configured in the Slave mode. The data transfer format is shown in [Figure 2-4](#).

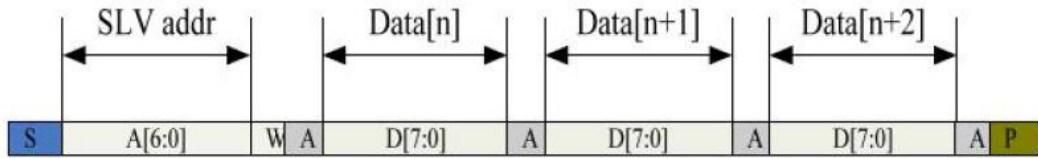
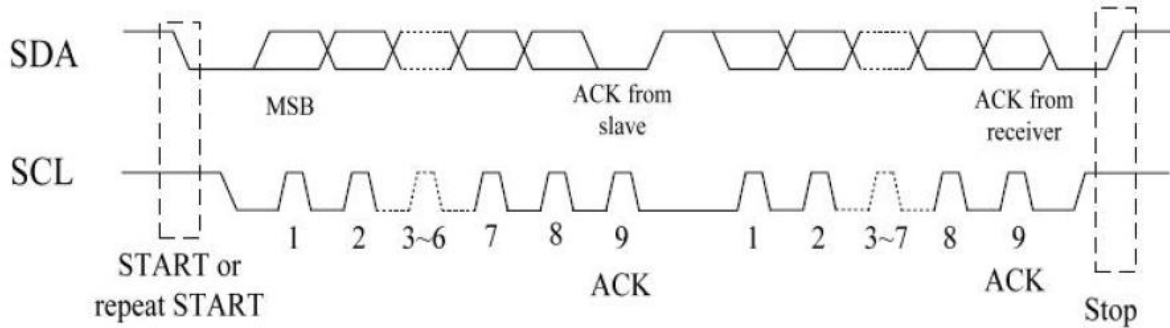

Figure 2-5 I2C master write, slave read

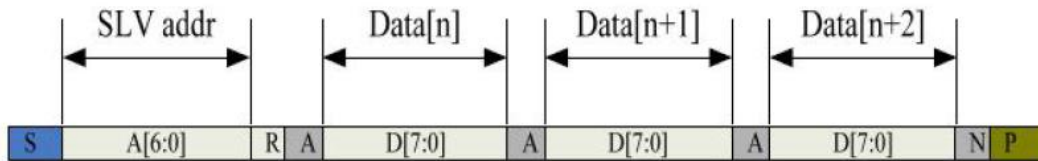

Figure 2-6 I2C master read, slave write

Table 2-1 lists the meanings of the mnemonics used in the above figures.

Table 2-1 Mnemonics Description

Mnemonics	Description
S	I2C Start or I2C Restart
A[6:0]	Slave address A[6:4]: 3'b011 A[3:0]: data bits are identical to those of I2CCON[7:4] register.
W	1'b0: Write
R	1'b1: Read
A(N)	ACK(NACK)
P	STOP: the indication of the end of a packet (if this bit is missing, S will indicate the end of the current packet and the beginning of the next packet)

I2C Interface Timing Characteristics is shown in Table 2-2.

Table 2-2 I2C Timing Characteristics

Parameter	Unit	Min	Max
SCL frequency	KHz	0	400
Bus free time between a STOP and START condition	us	4.7	\
Hold time (repeated) START condition	us	4.0	\
Data setup time	ns	250	\
Setup time for a repeated START condition	us	4.7	\
Setup Time for STOP condition	us	4.0	\

6. Optical Specifications

Item	Symbol	Condition	Min.	Typ.	Max.	Unit	Note
Viewing Angle (CR≥10) B/L ON	θ_T	$\Phi=90^\circ$ (12 o'clock)	75	80	-	deg	Note2
	θ_B	$\Phi=270^\circ$ (6 o'clock)	75	80	-	deg	Note2
	θ_L	$\Phi=180^\circ$ (9 o'clock)	75	80	-	deg	Note2
	θ_R	$\Phi=0^\circ$ (3 o'clock)	75	80	-	deg	Note2
Response Time	T_{ON}	Normal $\theta=\Phi=0^\circ$	-	12	17	msec	Note4
	T_{OFF}		-	12	17	msec	Note4
Contrast Ratio	CR		1000	1500	-	-	Note1 Note3
Color Chromaticity	W_X		0.268	0.318	0.368	-	Note1 Note5
	W_Y		0.307	0.357	0.407	-	Note1 Note5
Luminance	L		900	1000	-	cd/m ²	Note1 Note7
Luminance Uniformity	Y_U		75	80	-	%	Note1 Note6
NTSC	-		52.0	57.3	-	%	-

Note 1: Definition of optical measurement system

The optical characteristics should be measured in dark room. After 5 minutes operation, the optical properties are measured at the center point of the LCD screen. All input terminals LCD panel must be ground when measuring the center area of the panel.

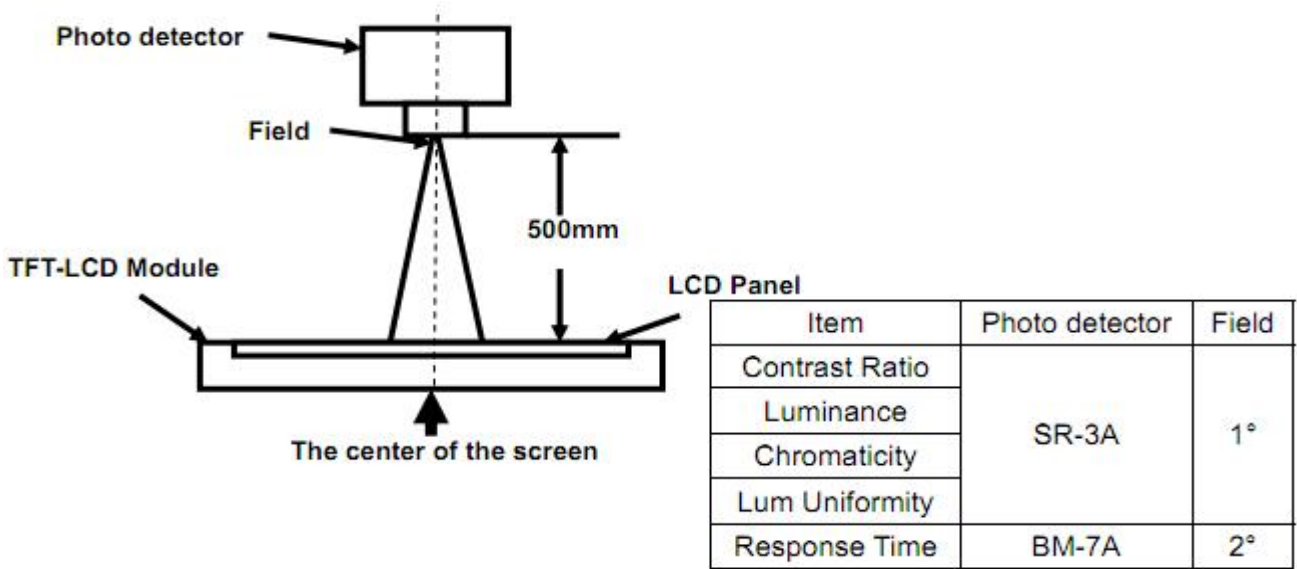

Note 2: Definition of viewing angle range and measurement system
 Viewing angle is measured at the center point of the LCD by CONOSCOPE(ergo-80).

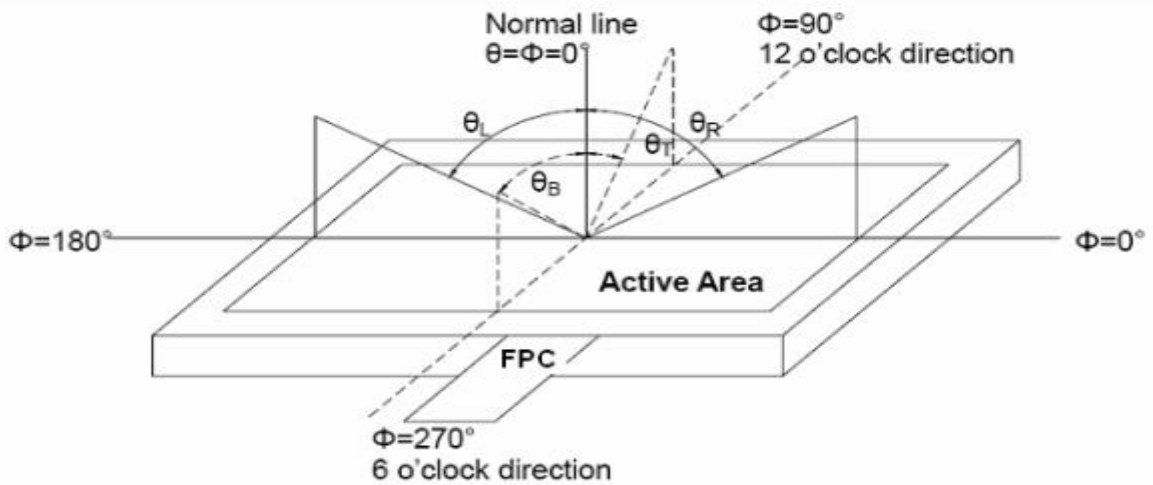

Fig. 1 Definition of viewing angle

Note 3: Definition of contrast ratio

$$CR = \frac{\text{Luminance with all pixels white}}{\text{Luminance with all pixels black}}$$

Note 4: Definition of Response time

The response time is defined as the LCD optical switching time interval between “White” state and “Black”state. Rise time (TON) is the time between photo detector output intensity changed from 90% to 10%. And fall time (TOFF) is the time between photo detector output intensity changed from 10% to 90%.

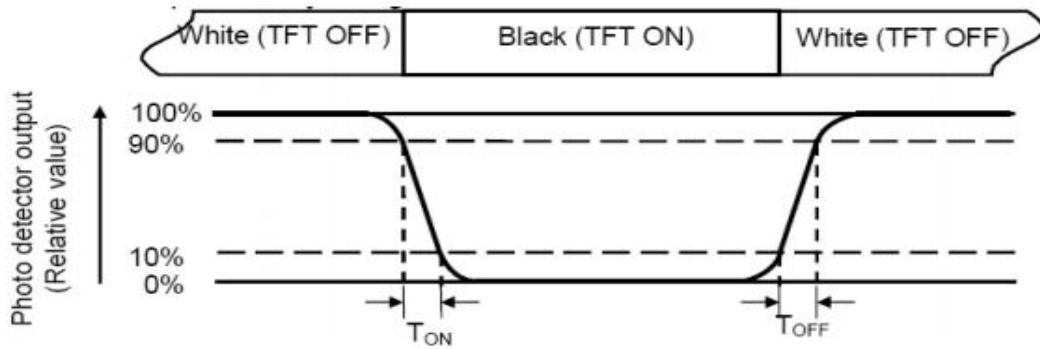

Note 5: Definition of color chromaticity (CIE1931)

Color coordinates measured at center point of LCD.

Note 6: Definition of Luminance Uniformity

The luminance uniformity in surface luminance is determined by measuring luminance at each test position 1 through n, and then dividing the maximum luminance of n points luminance by minimum luminance of n points luminance. For more information see FIG.2.

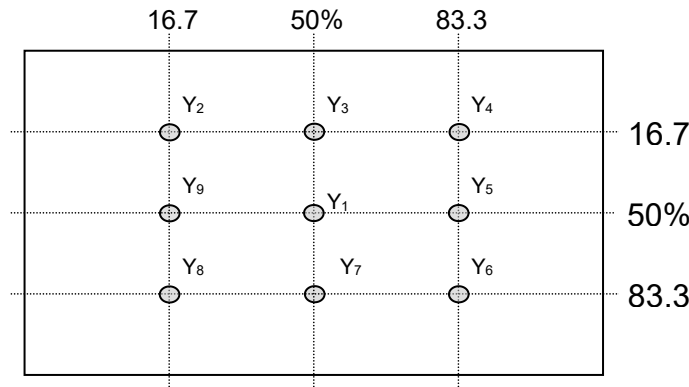

Fig. 2 Definition of points

Note 7: Definition of Luminance (Refer Fig. 2)

Surface luminance is the luminance with all pixels displaying white.

$L_v = \text{Average Surface Luminance with all white pixels}(P_1, P_2, P_3, \dots, P_n)$.

7. Reliability Test Items

Test Item	Test Conditions
High Temperature Storage	Ta= +80°C 96hrs
Low Temperature Storage	Ta= -30°C 96hrs
High Temperature Operation	Ta= +70°C 96hrs
Low Temperature Operation	Ta= -20°C 96hrs
High Temperature and Humidity Storage	Ta= +60°C, 90% RH 96hrs
Thermal Shock (Non-operation)	-30°C/30 min ~ +80°C/30 min for 20 cycles Start with cold temperature end with high temperature
Electro Static Discharge	Contact = ± 4 kV, class B Air = ± 8 kV, class B R=330Ω,C=150pF
Vibration	Sweep: 10Hz~55Hz~10Hz Stroke: 1.5mm 2 hrs for each direction of X .Y. Z.
Mechanical Shock	60G 6ms,±X,±Y,±Z 3 times for each direction
Package Drop Test	Height: 60 cm 1 corner, 3 edges, 6 surfaces

Notes: The test result shall be evaluated after the sample has been left at room temperature and humidity for 2 hours without load. No condensation shall be accepted. The sample will not be accepted if appear these defects:

- 1). Air bubble in the LCD
- 2). Seal leak or Glass crack
- 3). Non display or abnormal display
- 4). Brightness reduction >50%

8. Mechanical Drawing

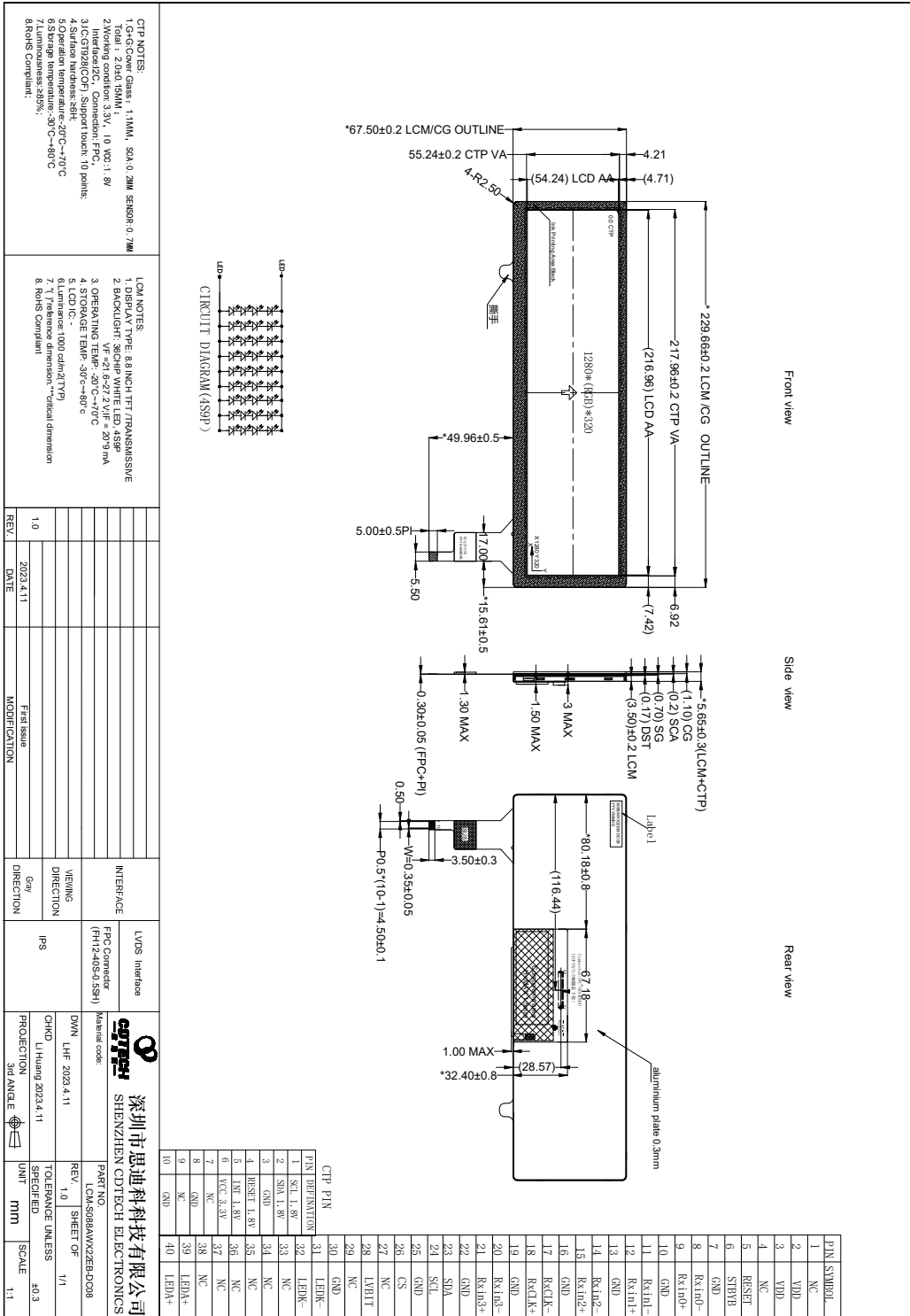

9. Packing

Packing Method

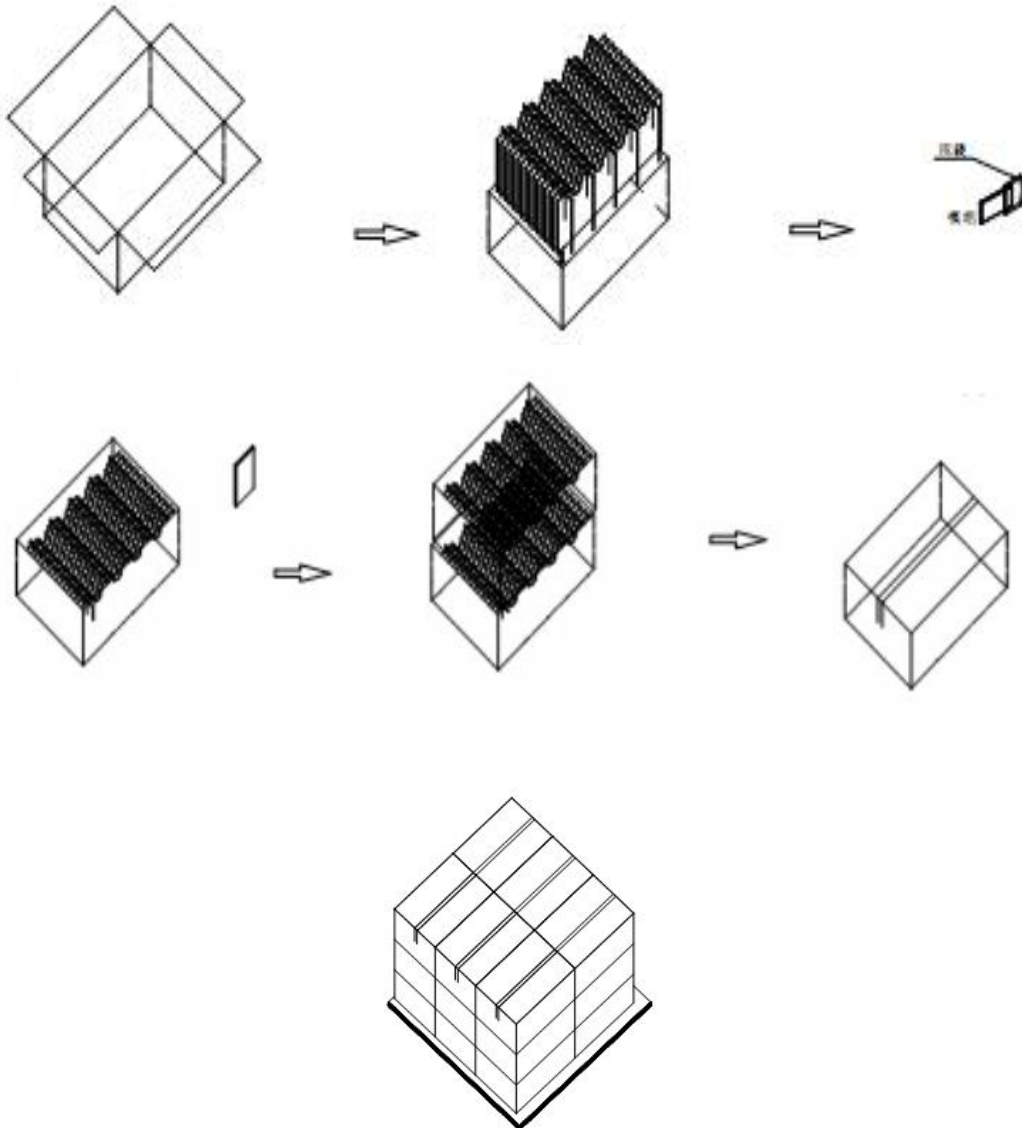

Steps:

1. Put module into tray cavity
2. Tray stacking
3. Put 1 cardboard under the tray stack and 1 cardboard above
4. Fix the cardboard to the tray stack with adhesive tape
5. Put the tray stack into carton
6. Carton sealing with adhesive tape

10. Precautions for Use of LCD modules

10.1 Handling Precautions

10.1.1. The display panel is made of glass. Do not subject it to a mechanical shock by dropping it from a high place, etc.

10.1.2. If the display panel is damaged and the liquid crystal substance inside it leaks out, be sure not to get any in your mouth, if the substance comes into contact with your skin or clothes, promptly wash it off using soap and water.

10.1.3. Do not apply excessive force to the display surface or the adjoining areas since this may cause the color tone to vary.

10.1.4. The polarizer covering the display surface of the LCD module is soft and easily scratched. Handle this polarizer carefully.

10.1.5. If the display surface is contaminated, breathe on the surface and gently wipe it with a soft dry cloth. If still not completely clear, moisten cloth with one of the following solvents:

- Isopropyl alcohol
- Ethyl alcohol

Solvents other than those mentioned above may damage the polarizer. Especially, do not use the following:

- Water
- Ketene
- Aromatic solvents

10.1.6. Do not attempt to disassemble the LCD Module.

10.1.7. If the logic circuit power is off, do not apply the input signals.

10.1.8. To prevent destruction of the elements by static electricity, be careful to maintain an optimum work environment.

10.1.8.1. Be sure to ground the body when handling the LCD Modules.

10.1.8.2. Tools required for assembly, such as soldering irons, must be properly ground.

10.1.8.3. To reduce the amount of static electricity generated, do not conduct assembly and other work under dry conditions.

10.1.8.4. The LCD Module is coated with a film to protect the display surface. Be care when peeling off this protective film since static electricity may be generated.

10.2 Storage Precautions

10.2.1. When storing the LCD modules, avoid exposure to direct sunlight or to the light of fluorescent lamps.

10.2.2. The LCD modules should be stored under the storage temperature range if the LCD modules will be stored for a long time, the recommend condition is :

Temperature : 0°C ~40°C Relatively humidity: ≤80%

10.2.3. The LCD modules should be stored in the room without acid, alkali and harmful gas.

10.3 Transportation Precautions

The LCD modules should be no falling and violent shocking during transportation, and also should avoid excessive press, water, damp and sunshine.